



spectrUM DISCOVERY AREA

# Making & Tinkering

COOKBOOK

VERSION 2.0

UNIVERSITY OF MONTANA

# spectrUM DISCOVERY AREA's Making & Tinkering INITIATIVE

Powered by **THE Martin Family** FOUNDATION

spectrUM Discovery Area is the University of Montana's hands-on science center, dedicated to inspiring a culture of learning and discovery for all. Since 2007, spectrUM has engaged pre-K-12 students and their families with STEM, higher education, and STEM career pathways at our Missoula museum and through statewide mobile programming. Since 2017, we have served as an anchor partner at EmPower Place, a free family learning center within Missoula Food Bank and Community Center. Our museum hub is now located within the new Missoula Public Library.

With seed funding from the Martin Family Foundation, spectrUM began working in 2016 with several long-standing partners in Montana's rural Bitterroot Valley to build community capacity for making and tinkering programming, including in K-12 schools. spectrUM's making and tinkering programs manager Nick Wethington co-facilitated activities alongside elementary and middle school teachers throughout the academic year and launched the annual Making and Tinkering Institute - a professional development workshop for formal and informal educators – and the Bitterroot Maker Fair, an annual showcase of this collaborative work for the community.

This Making and Tinkering Cookbook is the culmination of these efforts and has been shaped and refined with collaborating teachers, as well as spectrUM's multi-sector Bitterroot STEAM Advisory Group. The activities featured in this booklet were initially prototyped at spectrUM's museum makerspace before traveling out to K-12 classrooms in the Bitterroot.

spectrUM's making and tinkering initiatives have since expanded to include exhibits, programming, and educator professional development supported by the Jane S. Heman Foundation, Cognizant, and the Institute of Museum and Library Services. We look forward to continuing to refine and expand this resource with input from students, teachers, and partners.

You can learn more about spectrUM's making and tinkering initiatives by visiting [spectrum.umt.edu](http://spectrum.umt.edu). You can also watch a video created by MAPS Media Institute at [tinyurl.com/spectrumimpact](http://tinyurl.com/spectrumimpact) or by scanning this QR code.



To learn more about the learning ecosystem we've curated with a host of other organizations, see "Design Elements From a Rural, Multi-Organization Collaborative: The Bitterroot Valley Learning Ecosystem," published in the December, 2019 issue of Connected Science Learning and reprinted on page 4-9.

# Table of Contents

The Making and Tinkering Ethos.....	4		
<i>Design Elements From a Rural, Multi-Organization Collaborative</i> .....	6	Activity 8:	
Activity 1:		Circuit Blocks.....	28
Bouncy Rockets.....	12	Activity 9:	
Activity 2:		Forced Perspective Photography.....	32
Ozobots.....	14	Activity 10:	
Activity 3:		Strawbees .....	36
Zipline Racers .....	16	Activity 11:	
Activity 4:		Paintbrushes and Cochineal Painting .....	38
Hovercrafts.....	18	Activity 12:	
Activity 5:		Cardboard Construction .....	40
Light Play .....	20	Activity 13:	
Activity 6:		Chocolate Welding.....	42
Squishy Circuits .....	22	Appendix.....	46
Activity 7:		NGSS Standards Addressed.....	50
Makey Makey.....	26	Acknowledgements .....	53

## Design Thinking Process



# Making & Tinkering

## ETHOS



Making and tinkering is both very hard and very easy to define. A simple distillation is that it is learning through the process of design, iteration, and failure.

But it's much more than that, hitting some fundamental aspects of what it is to be humans and shape the world around us by exploring the nature of various materials.

Allowing students to struggle and succeed is the most important thing to take away from these activities. The loose "step-by-step" nature of these instructions is meant to be a helpful guide for those who haven't had exposure to the facilitation of these activities. Our favorite way to present these activities is to show an example of the item to be created or end-goal of a process, and challenge the students to reverse-engineer the item using their own ideas and thoughts about what the process should be. While some basic instructions and safety guidelines are necessary to introduce at the beginning of each activity, an open-ended process of playing, thinking and tinkering with the design to approximate the end goal is what is most important. To that end, here are a few strategies to get in the mindset of facilitating making and tinkering activities.



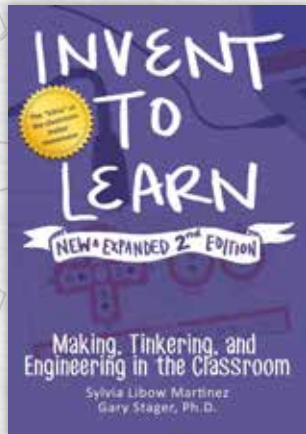
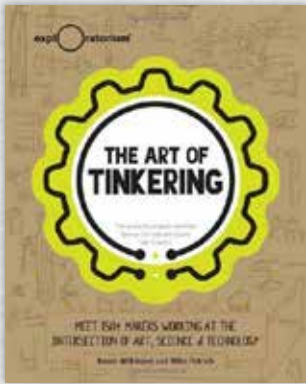

- **Resist the urge to step in and help the students all of the time.** A good rule of thumb is to help when they ask or get overly frustrated, but generally leave the process of design up to them. One teacher from the first year's evaluation said it best: "It's important not to steal their struggle."
- **When help is required, ask the student what they are trying to achieve at this step of their design.** Then ask how they think they might use the tools and information available to them to meet that goal. Give input on their ideas, never saying "that won't work", but rather, "how do you think that will help you get to the next step?" or "what problems do you see with that idea that you might have to solve?"
- **Ask questions rather than give answers when possible.** Instead of saying, "Don't put glue on the inside of the rocket straw because it will make your rocket not launch very well," ask, "Do you think you want any glue on the inside of the straw? Why not?"
- **Failure and iteration are important.** It's only when a student has really struggled through the process that they can be empowered to have ownership over what they create. To that end, a prototype that ends up being a large ball of oozing hot glue that will get thrown in the trash is okay - it will identify one way not to go about creating the desired object or process.
- Even though it may take a few prototypes to get to a good final design, **quality over quantity is important to stress.** Many kids want to crank out three or four of whatever it is that is being designed, but it's hard to make high-quality, functional designs in a short class time. Stress at the beginning that a working design that you can be proud of is worth more than three that don't work very well or at all. Have them focus on trying to make one good one, refine it, then think about what you would create given the time and opportunity to make another.
- While competition has its place in the world otherwise, a big part of the maker ethos is to do things out of a desire to craft something that represents your ideas, perspective on the world, ingenuity, etc., and not necessarily for an award or to see which is the "best". With that in mind, **it's great to have various metrics for success.** As an example, for Bouncy Rockets, it's helpful to encourage the students to make a rocket that flies very high, but also one that tumbles the most, or flies the straightest, or has the most fins/least fins, or is the smallest/tallest, or flies the craziest, or has the most pink...you get the idea. A successful design is one that the creator can be proud of in its own right.
- Decoration and personalization of the objects created in these activities is important, so try and leave time when possible and put out things like markers or different colored paper to encourage this. **Art and narrative are central to making.**
- Lastly, **there's no "right way" or "wrong way" to create any of the items or do any of the activities in this booklet.** All have a component built in where the participant must make a leap into a design of their own making - that leap is more important than anything else. To that end, ideas directly generated by the kids have been incorporated into many of the activities, and they are much better for that. **Makers learn from each other, just as teachers learn from students.**

For more resources on the making ethos and strategies for implementing activities or encouraging this mindset, see the following resources:  
**Making Makers** by AnnMarie Thomas • **Zero to Maker** by David Lang • **Launch** and **Empower** by John Spencer  
**Invent to Learn** by Sylvia Libow Martinez & Gary Stager • **The Art of Tinkering** by Karen Wilkinson & Mike Petrich



## Design Elements From a Rural, Multi-Organization Collaborative The Bitterroot Valley Learning Ecosystem

By Beth Covitt, Vic Mortimer, Nick Wethington, and Nathalie Wolfram

On a Saturday afternoon last May in Hamilton, Montana, 150 people gathered in a college gymnasium for the Bitterroot Maker Fair. At tables around the room, student educators from the University of Montana (UM) spectrUM Discovery Area guided K-12 students and their families in activities such as jigsaw-puzzle creation and forced-perspective photography. A group of students clustered around a robotics station where they programmed Cubelets; many were already familiar with the modular robotic blocks from in-school making and tinkering experiences co-led by spectrUM educators and local K-12 teachers. Students from Hamilton Middle School's SciGirls Code Club displayed the robots they had created at the school library, and the middle school Science Olympiad team led interactive chemistry demonstrations. Down the hall, visitors toured the Bitterroot FabLab, where they explored virtual reality challenges and learned about rapid-prototyping technologies available for use by members.

The Maker Fair is one programming highlight of a vibrant STEM (science, technology, engineering, and math) learning ecosystem in the rural Bitterroot Valley, where spectrUM, K-12 schools, public libraries, community organizations, and a community advisory group collaborate to engage students with local education and career pathways. All year round, both in school and out, the ecosystem supports a web of interconnected STEM learning experiences designed to close opportunity and achievement gaps and foster a homegrown STEM workforce.

Based in nearby Missoula, spectrUM serves as a backbone for this collective work and delivers making and tinkering programming designed to promote essential education and workforce skills such as persistence, creativity, teamwork, and communication. spectrUM has partnered with schools in the Bitterroot for a decade to deliver STEM programming, but when we adopted a more deliberately collaborative, ecosystem-minded approach, we were able to evolve to create locally responsive STEM programming, broaden participation, and build capacity in local schools and community organizations. This article shares some of the key design elements that we have identified for fostering multisector collaboration to support a healthy STEM learning ecosystem that meets the unique needs of rural communities.



## The local context

As a community-focused science center based at a university that serves a large, sparsely populated state, spectrUM engages more people outside our walls than we do in our brick-and-mortar museum. To engage students in rural and tribal communities statewide, spectrUM's Science on Wheels program transforms school gyms and public libraries into pop-up science museums. Regionally, spectrUM partners with communities to codesign STEM programming that responds to local needs and priorities. In the Bitterroot Valley, our partners are particularly focused on creating pathways for K–12 students into locally robust sectors such as health care and biotech, but also into fields such as entrepreneurship, manufacturing, construction, and the trades, which require STEM literacy but not necessarily a bachelor's or graduate degree.

The Bitterroot is economically diverse, with major employers such as the National Institutes of Health's Rocky Mountain Laboratories and GlaxoSmithKline operating alongside over 1,400 small businesses (10 employees or fewer) in a county of just over 42,000 people. Forty-four percent of new jobs in the county are created when new businesses open (Ravalli County Targeted Economic Development District Plan 2015). Innovation and entrepreneurship play a vital role in Montana's economy as a whole; for two recent years, the Kauffman Index ranked the state number one in startup activity among the 25 less populous states.

Yet persistent inequality and social immobility prevent many K–12 students in the Bitterroot from advancing into STEM-related career pathways. In Hamilton and Corvallis, two communities that form the hub of this STEM learning ecosystem, over 20% of residents live in poverty, and the median income is less than 60% of what it is statewide. Anecdotally, spectrUM's partners and community advisory group report that many K–12 students are unaware of local opportunities for fulfilling careers, including those attainable with a two-year degree or certificate.

With funding from two family foundations committed to closing these gaps, spectrUM convened a Bitterroot community advisory group in 2017 to set a collective vision, codesign spectrUM's local programming, and ultimately build local STEM education capacity in the community. The group's members included partners spectrUM had collaborated with in the Bitterroot for years, as well as representatives from schools and organizations that our partners identified as community assets and STEM education leaders.

Today, the Bitterroot STEAM (science, technology, engineering, art, and math) Advisory Group includes K–12 teachers and principals, two high-school students, and representatives from the local library, county museum, and hospital. The group's monthly meetings create space to cross-pollinate ideas and spark new collaborations, as well as to develop and refine all of spectrUM's programming in the Bitterroot, which currently includes:

- The Bitterroot Summer of Science, which brings free making and tinkering programming to libraries and community organizations throughout the valley
- In-school making and tinkering programming and teacher professional development
- The annual Bitterroot Maker Fair, cohosted with UM's Bitterroot College
- Facilitated design charrettes that support schools in creating their own in-school makerspaces
- Other programming led by spectrUM's partners in the Bitterroot, which often aligns or is interwoven with programming offered by spectrUM

Although evaluation of the Bitterroot STEM Learning Ecosystem has been designed to provide both formative and summative findings, greater emphasis is placed on formative evaluation, with the goal of facilitating ongoing program refinement. Evaluation questions focus on eliciting the experiences and perceptions of both the ecosystem partners (e.g., spectrUM personnel, library and other museum personnel, K–12 educators and administrators) and the ecosystem audiences (e.g., families attending Summer of Science events). Combinations of interviews and surveys are used to collect data, and each year a report is written to (1) articulate successes and challenges associated with the ecosystem collaboration and programming, and (2) provide suggestions for changes, which emerge from evaluation responses. Further, each year, evaluation questions are updated and revised to realign with the most current issues and questions facing the ecosystem. A guiding principle of the evaluation is to make sure that voices representing the spectrum of project stakeholders are accurately and adequately represented. Each year, we have conducted interviews with representatives from the various partner organizations, including administrators, educators, and coordinators. We elicit feedback from participating children with short, child-accessible surveys. In addition, we elicit feedback from adults who bring children to events through both surveys collected at all events and interviews conducted with a small purposive sample each year. This principle has helped make the evaluation a critical tool for shaping growth and changes within the ecosystem, making it responsive to both partners and community members. Through this partnership, and with careful and deliberate use of insights from evaluation and direct experience, we have developed the following design elements for a healthy rural STEM learning ecosystem.

## Collaborate across formal and informal education settings to create STEM engagement that both sparks students' interest and excitement, and encourages them to dive deeper.

Drawing on Traphagen and Traill's (2014) strategies for fostering an effective STEM learning ecosystem, our collective work in the Bitterroot scaffolds STEM learning experiences across formal and informal settings. This structure encourages progressive engagement in which students encounter experiences that spark their curiosity and opportunities to engage in deeper, more sustained learning.

Although these two broad types of STEM learning—the spark and the deeper dive—sometimes correspond to informal versus formal learning settings, respectively, we have found that our collaborative approach blurs this

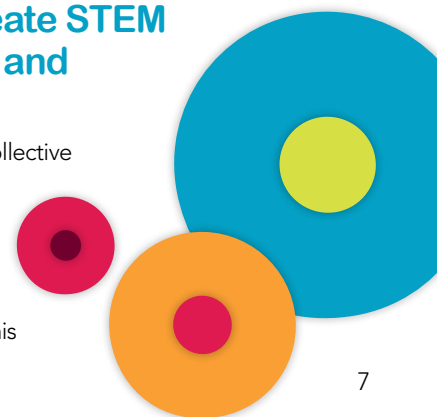

distinction. For example, spectrUM's in-school making and tinkering experiences, cofacilitated by teachers, effectively turn classrooms and school libraries into pop-up makerspaces where students are encouraged to adopt the maker mindset and engage in open-ended, playful design activities—such as building bouncy rockets and zip-line racers—often found in informal, out-of-school settings. Our evaluation has found that these hybrid formal–informal experiences create on-ramps into STEM for many students who have not previously identified themselves as academically successful. At Corvallis Middle School, fifth-grade teacher Amanda Bestor says, “Students who may not always shine in a traditional math or writing lesson can show knowledge in a different way and often excel at making and tinkering. It builds confidence in their work and their ability to work through a challenge.”

Although activities designed to spark curiosity and excitement can be an end in themselves, teachers often develop them into deeper, more sustained experiences that incorporate inquiry-based and other formal approaches to STEM learning. Bestor says that cofacilitating making and tinkering activities with spectrUM has influenced her teaching across the curriculum; when developing new lessons, she now also looks at “how students collaborated during the building activity. Did they incorporate other members’ ideas? Did they go back to their original design and improve upon it?” The payoff of this approach, she says, manifests in students’ perseverance, which transfers into other types of learning throughout the school day.

Blending formal and informal STEM experiences also engages students as leaders and near-peer mentors, an outcome we did not anticipate at the outset of this collaborative work. At Corvallis Middle School, a group of girls who had participated in making and tinkering in their classroom approached the school librarian with an idea for a club that would meet during recess. The “STEM 5” launched their club last school year, developing their skills as mentors and peer educators while engaging a wider student audience in making and tinkering. By design, community events such as the Bitterroot Maker Fair and the Summer of Science also encourage students involved in informal STEM at school—whether through spectrUM's making and tinkering programming or through clubs such as Science Olympiad, the SciGirls Code Club, or the Keystone afterschool program—to facilitate activities with their peers and community members.

## Be responsive and evolve over time.

A locally responsive, community-based approach takes time and willingness to adapt. With our advisory group, spectrUM engages Bitterroot schools and community organizations as partners rather than as clients in order to build mutually beneficial, trusting relationships. These relationships are vital in maximizing the impact of our programming by, for example, engaging with children at summer free-meal sites and free or reduced-cost summer and afterschool programming. At these sites, we have found through program evaluation that we reach students whose parents are unable to travel the farther distance to Missoula for STEM enrichment, even if it is offered for free.

Crucially, our approach to rural engagement uses an asset rather than a deficit model. We recognize that communities in the Bitterroot have unique resources and assets that we can collectively leverage. In spectrUM's making and tinkering programming in the Bitterroot, students regularly draw on their personal funds of knowledge from experiences such as hunting, setting and repairing traps, and fixing cars (Moje et al. 2001). Accordingly, one teacher was inspired by spectrUM activities to develop an “animal trap” activity in which students create traps designed to capture an Ozobot, a small, line-following robot that is programmable with color codes. In another activity, students visited the school library to research a local insect; gathered materials such as rocks, leaves, and sticks from outside; and created a model of their insect using the hot glue guns that have become a fixture of making and tinkering activities at the school library.

In many rural Bitterroot communities, children also have free range to travel to our programming by bicycle, often unaccompanied by adults. In Darby, Montana, we situate our summer events in the town park, adjacent to a community free-meal site and the public library, creating a one-stop shop for children. Recognizing these assets and aligning our program design and delivery with them helps scaffold students’ experiences and make connections between STEM and their everyday lives.

## Know what roles the partner organizations in the ecosystem want to and can play. Be willing to compromise, and don't try to be the one organization that does it all.

Meeting our partners where they are—and where they want to be—has been essential in our collaboration. Some partners have interest in and capacity for playing an active role in codesigning programming. The Ravalli County Museum and Historical Society, for instance, has curated exhibits that complement spectrUM's STEM exhibits and has incorporated activities developed by spectrUM and Rocky Mountain Laboratories into their existing Saturday STEAM programming.

Other partners are able to commit a more moderate effort to our collaboration. These partnerships can be highly effective as long as partners are mutually clear about expectations. One library we work with does not have space to host a full exhibit but was excited to host drop-in spectrUM programming. Another library was interested in embedding high-tech experiences, such as 3-D printing for demonstrations and spectrUM-led activities, but did not have the staff capacity to engage in professional development and take on this programming themselves. In both cases, we collaborated effectively and, as indicated in our evaluation, maintained mutually beneficial partnerships by identifying areas of alignment and respecting our partners’ stated needs, interests, and capacity.

Prioritizing long-term capacity-building within the community, even as spectrUM remains a partner in program delivery, has resulted in STEM programming that is locally relevant and far more sustainable than if spectrUM were to take a more siloed, less collaborative approach. For





example, in 2016, the national SciGirls organization invited spectrUM to implement a new girls' coding club. We were excited about the opportunity, but rather than incorporating it into our own educational programming, we partnered with Hamilton Middle School to embed the club in their school library. Hamilton's middle-school and elementary librarians received robust professional development, curriculum materials, and start-up funding from Twin Cities PBS SciGirls for Hamilton's first SciGirls Code Club, with spectrUM recruiting STEM role models from the UM as a supplement. Following the club's pilot year, the school has fundraised locally to continue the club long-term and to affiliate with the national Girls Who Code organization as well.

## Designate a central project manager to facilitate communication and collaboration.

One essential role we have identified in our ecosystem is a central project manager who facilitates interorganizational communications and coordinates logistics. To use a cell system analogy, this person serves as the nucleus for collaboration activities.

The coordinator does not necessarily have to be the same person throughout the multiple years of the partnership, as long as there is consistently a person who can effectively fulfill this role, and, importantly, has the time and resources needed to do so. For organizations not located in the community being served, it might be worthwhile to designate (and pay) a liaison within the community who can help network with and recruit new partners and support implementation with a highly local perspective.

## Go to where the audience is—at as local a scale as possible.

spectrUM's engagement has always included mobile programming, which is essential for reaching communities in our large, rural state. Influenced by "Just Add Science," the Science Festival Alliance's program to embed science in existing community events, spectrUM's Bitterroot Summer of Science was deliberately designed to drop STEM exhibits and programming into existing community gathering places, including not only fixed sites such as the county museum and public libraries, but also seasonal events such as the weekly farmers' market, the county fair, free-meal programs, and community picnics and celebrations. By leveraging existing community gathering places and events, we are able to reach audiences that might not otherwise seek out or feel welcome in traditional science museum settings.

Yet initially, our evaluation suggested that even by embedding at well-attended community sites, we were still not going local enough. In the first iteration of Summer of Science, from 2015 to 2017, each summer's programming was anchored in one community: at the Ravalli County Museum & Historical Society in Hamilton in 2015, at the Darby Community Public Library in 2016, and at the North Valley Public Library in Stevensville in 2017. This static, intensive approach—with educator-led programming offered weekly throughout the summer and self-guided exhibit installations—created a sense of cohort among children and families who regularly attended. But parents and partners also expressed disappointment that the programming would move to a different community the following summer. Consistently, our evaluation indicated that parents could not or would not travel to other towns in the Bitterroot for other Summer of Science events. Barriers included parents' work commitments, driving costs, and lack of transportation.

In response, beginning in summer 2018, we refined our approach to be hyper-local. Summer of Science now roves up and down the Valley; in summer 2019, we reached seven sites in four communities over the course of 18 visits. With this more agile approach, we shifted away from large exhibits toward more mobile activities that are easily transported between communities. To ensure that children and families still know where and when to find us, we ramped up our marketing with postcards, a mailed advertisement, posts on the local online events calendar, and signage and small anchor exhibits at community hubs such as the Ravalli County Museum and Historical Society. Because of our strong partnerships with K–12 teachers, librarians, and our advisory group, Summer of Science also benefits from strong word-of-mouth marketing by trusted community members.

The results of this shift toward hyper-local engagement have been striking. Parents have consistently reported to the evaluator that they appreciate having some events in their own community during the summer, even if Summer of Science events occur only monthly instead of weekly. Families share that while the more frequent events were nice, they are not necessarily missed, because partner organizations provide other, complementary events. For example, in June 2019, Stevensville's North Valley Public Library offered youth science programming—beyond spectrUM's Summer of Science events—related to insect life cycles, adaptations, and plant seed engineering. The library also offered nonscience youth programming such as reading clubs, yoga classes, and telling traditional stories from the Séliš (Salish) people of Montana. Events such as these are generally offered without cost to community members.

By working with spectrUM and other regional partners, youth service-providing organizations such as libraries in the Bitterroot have become summer hubs that provide so much more than the opportunity to borrow a book. In essence, the Bitterroot learning ecosystem has turned the catchphrase "if you build it, they will come" on its head. We have found instead that if you come to rural communities, they can and will leverage diverse opportunities to build rich and vibrant networks of youth development programming.



Many children walk or bike to spectrUM's Summer of Science programming, where they can drop in and try out activities such as Cardboard Construction.

## Plan for capacity-building rather than just program delivery.

Building capacity in the community not only helps ensure sustainability, but it also gives the community the agency to take programming in new directions and make it locally relevant. The benefits of capacity-building are especially evident in spectrUM's partnership with K–12 schools in Hamilton and Corvallis, where teachers cofacilitate making and tinkering activities alongside spectrUM's making and tinkering program manager Nick Wethington, who provides robust, ongoing professional development. In the last three years of this partnership, over 40 teachers, school librarians, and informal educators have participated in an annual, two-day Making and Tinkering Institute. Led by Wethington and modeled in part on the work of the Museum of Discovery's Discovery Network in Arkansas, the institute provides a hands-on introduction to making and tinkering activities and has brought in guest facilitators from the Science Museum of Minnesota, the Museum of Discovery, and UM's Phyllis J. Washington College of Education and Human Sciences. Teachers receive stipends for their participation, as well as making and tinkering supplies and spectrUM's Making & Tinkering Cookbook, which was codeveloped with K–12 teachers. The Making and Tinkering Institute is a chance for the participants to take a very deep dive into the activities facilitated by Wethington in classrooms, collaborate with professional peers from districts and schools other than their own, and share best practices. Attendees from prior years serve as peer mentors, sharing their experience facilitating the activities and adapting them to support other areas of their teaching. The institute also creates a space to workshop new activities, engaging teachers as partners in shaping and refining them.



To market hyper-local programming that occurs at multiple sites throughout the summer, spectrUM places anchors such as this Makey Makey electronic invention kit at libraries and other community hubs.

Throughout the school year, Wethington cofacilitates making and tinkering activities with teachers in their classrooms and school libraries. Daly Elementary principal Nate Lant characterizes this approach as “I do, we do, you do.” First, Wethington leads professional development for teachers and directly facilitates activities with K–12 students (“I do”); then Wethington cofacilitates with teachers (“we do”); then teachers adopt the activities into their own curriculum (“you do”). As previous years' teacher cohorts complete this sequence, they continue serving as peer mentors for a new cohort. This approach is consistent with the learning theory of cognitive apprenticeship, which involves phases of modeling, coaching, and fading (Collins, Brown, and Holum 1991). Cognitive apprenticeship has been shown to support individuals who begin as novices in a complex skill in developing mastery over time.

As school capacity grows, spectrUM's Making and Tinkering Institute has also evolved to be increasingly collaborative and draw on participating teachers' and principals' growing expertise and sense of ownership. At the 2018 institute, teachers and librarians from multiple school districts engaged in a facilitated discussion about how to embed a physical makerspace into their school in a way that meets each school's unique needs and characteristics. The conversation also included a brainstorm about how to leverage existing resources to achieve the goal of deeply embedding the making ethos into the school's daily curriculum.

These capacity-building efforts have also sparked new collaboration between school districts. Beginning in fall 2019, a multidistrict Peer Learning Community co-organized by a Corvallis teacher and spectrUM brought together teachers from across grade levels and districts. Through regular meetings that will count toward professional development requirements, teachers will share ideas and practices for weaving making and tinkering into other areas of their teaching. Although building on spectrUM's programming and professional development, the Peer Learning Community is organized by and for the local schools. Schools' and teachers' commitment to peer learning and mentorship is vital to the sustainability of the STEM learning ecosystem. Although spectrUM has built strong relationships with family foundations that are dedicated to our success and supportive of innovative STEM education practices, it is ultimately the teachers, principals, school librarians, and informal educators in the community who are building the knowledge and expertise to weave the maker mindset—and making and tinkering practices—permanently into their teaching and programming.

## Create synergies that leverage and multiply impacts.

Trusting and codesigning with our partners sparked collaborations that took on a life of their own and evolved in ways we never anticipated at the outset of our grant funding. spectrUM's collaboration with Corvallis Middle School's library provides one representative example.

From the start of our partnership, Corvallis Middle School's staff imagined a making and tinkering program that would be closely tied to the school's curriculum and housed in the library. In fact, Vic Mortimer, the school librarian, and Rich Durgin, the school principal, had already begun discussing the possibility of establishing a makerspace in the library when spectrUM asked whether Corvallis would be interested in participating in a newly funded making and tinkering project. The offer met a need that the school had already identified, if not yet fully articulated.

The making and tinkering program that spectrUM brought to the first group of Corvallis Middle School fifth graders quickly became a favorite activity and sparked a degree of envy in older students who had not had the opportunity to work with bouncy rockets, zip line racers, Ozobots, or forced-perspective photography. Other teachers noticed the high level of student engagement that the program generated and began to ask about using some of the activities and materials in their own classrooms. Sixth- and seventh-grade language arts teachers, for example asked about using light play equipment for storytelling in their classrooms. Building on the original 50-minute light play activity that spectrUM cofacilitated with teachers, the librarian and language arts teachers from older grades designed more elaborate assignments that required

the construction of shadow puppets and two or three full class periods to plan, construct, and perform short plays. A seventh-grade social studies teacher worked with the librarian to create an activity in which students used light play to retell American Indian origin stories, a creative approach that supported this teacher in fulfilling Montana’s constitutional mandate of Indian Education for All. In the high school, a science teacher asked his students to use the light boxes to tell the story of a particular species of native fish. Across the grade levels, students filmed their peers’ presentations, incorporating digital storytelling into their learning experience.

With the library as a school hub for making and tinkering, other teachers from all grade levels and disciplines also began using materials from the collaboration to enhance their existing curriculum. The eighth-grade science teacher consulted with Wethington on how to build shake tables that students could use to test how different buildings hold up in earthquake conditions. The sixth-grade science teacher repurposed clay used for a squishy circuits activity for student projects involving atoms; later, she used circuit blocks made two years earlier for a unit on electricity, as well as other supplies for a “Newton car” design project. An eighth-grade math teacher developed a version of a “zip line Barbie” experiment in which teams of students planned and tested zip lines. The aim was to create an angle of descent steep enough “not to bore Barbie and not so steep that it would kill her.” The activity included budgeting for construction costs and calculating the angle of the zip line and the speed of descent. The activity took place in the library, where the librarian could assist.

More ideas are in development. Students in eighth-grade language arts will be creating podcasts and videos for book projects. In fifth grade, the librarian and a classroom teacher will begin “genius hour” activities, which blend STEM, project-based learning, and making and tinkering by asking students to research topics of interest and develop hands-on projects they can share with others.

Through this collaboration with spectrUM, the school library became a space where students can, in addition to checking out a book, develop the persistence and curiosity to make useful and beautiful things. Students get to know Mortimer, the librarian, who now leads many of the STEM labs, as students and teachers refer to the making and tinkering sessions, and many hang out during lunch and recess. Mortimer himself noted that, as someone who studied English in college, he sees the value of making and tinkering activities for pushing both students and teachers to expand their comfort zones.

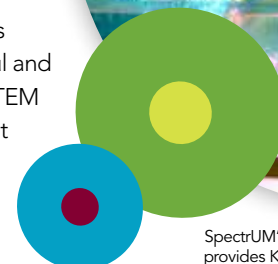

SpectrUM’s annual Making & Tinkering Institute provides K–12 teachers with robust professional development and kickstarts each school year’s cofacilitated activities in classrooms and school libraries.

## Conclusion

Recognizing that each community is unique, we do not expect that every approach that works in Montana’s Bitterroot Valley will succeed elsewhere. However, largely because the design elements have a strong focus on adaptability to place, we have found that these lessons learned in the Bitterroot often can transfer and provide insights for enriching our engagement in other rural and tribal communities:

- Collaborate across formal and informal education settings to create STEM engagement that both sparks students’ interest and excitement, and encourages them to dive deeper.
- Be responsive and evolve over time.
- Know what roles the partner organizations in the ecosystem want to and can play. Be willing to compromise, and don’t try to be the one organization that does it all.
- Designate a central project manager.
- Go to where the audience is—at as local a scale as possible.
- Plan for capacity-building rather than just program delivery.
- Create synergies that leverage and multiply impacts.

As our Bitterroot learning ecosystem continues to grow and evolve, so too might these findings, which we offer as design elements rather than a rigid formula. With a hyper-local, community-engaged, asset-based approach, the Bitterroot Valley of Montana provides one vivid and thriving example of what a high-quality STEM learning ecosystem can look like, and of what it can accomplish.

## Acknowledgments

spectrUM Discovery Area and our community partners are grateful to the Jane S. Heman Foundation and the Martin Family Foundation for their commitment to funding STEM education and career pathways–building in the Bitterroot.

Copyright © 2019 Connected Science Learning · All Rights Reserved

**Beth Covitt** ([beth.covitt@umontana.edu](mailto:beth.covitt@umontana.edu)) is head of science education research and evaluation at spectrUM Discovery Area at the University of Montana in Missoula, Montana.

**Vic Mortimer** ([vicm@corvallis.k12.mt.us](mailto:vicm@corvallis.k12.mt.us)) is school librarian for Corvallis Middle School in Corvallis, Montana.

**Nick Wethington** ([nicholas.wethington@umontana.edu](mailto:nicholas.wethington@umontana.edu)) is the making and tinkering program manager for spectrUM in Missoula, Montana.

**Nathalie Wolfram** ([nathalie.wolfram@umontana.edu](mailto:nathalie.wolfram@umontana.edu)) is director of the Broader Impacts Group at the University of Montana in Missoula, Montana.

# ACTIVITY 1: Bouncy Rockets

## Make a rocket that launches high into the air!

Conservation of energy has never been so fun! Each student makes a launcher and multiple rocket designs out of household items. This activity favors iteration of design, is quick to build, and easy to take home to the family dinner table.

These rockets fly pretty high depending on your design, up to 12 or 15 feet if dropped from just a standing position. Dropped off of a chair, staircase, or something further off the ground, they will travel even higher!

## SUPPLIES

- **Bouncy ball**
- **Straws** - paper works best, plastic is okay
- **Hot glue & glue guns** (recommended) or **tape** and **glue dots** for younger students
- **Scissors**
- **5/16" x 18 tpi hex nuts or 3/8"x 16tpi hex nuts - depending on straw diameter** (available at local hardware store or from McMaster-Carr, mcmaster.com, unit #90490A030)
- **3/16" dowel** (available at local hardware store or JoAnn Fabrics), cut to about 6" long
- **Drill bit and drill** (use a 3/16" - 1/4" drill bit)
- **Paper, craft foam, cardboard,** etc. for fin materials
- **Safety glasses** to use when launching rocket

**Time Needed:** 1 class period

**Grade Recommendation:** 1st-7th

### Preparation

To build your bouncy rocket, you must drill a hole into the bouncy ball. Teachers should do this step in advance.

- Find a spot on the bouncy ball that is far away from any seam. Do not drill into the seam, as this may split the ball.
- Using your drill and drill bit, drill a hole about halfway into the bouncy ball.

### Engage

Ask them to share what they know about rockets. How do they fly? What are the parts of a rocket? How do the parts of the rocket affect it's flight?

**POINTER:** Do not allow hot glue to get into the straw. This will make it difficult to launch!

## Explore

### BUILD THE LAUNCHER

To build the launcher, stick the dowel into the hole of the bouncy ball. Use hot glue if you would like. Don't push it too far, though, or it will split the ball.

### BUILD THE STRAW ROCKET

Your students can build the straw rocket any way they would like.

As with most making and tinkering, students' imagination and individual design ideas should guide them. Here are a few tips:

- Cut a straw to the length you would like. It's helpful to have it just a bit shorter than the launcher stick for better launches.
- Fins make the rocket more stable. What shape would you like to make them?
- Adding weights may make the rocket fly with more stability.

## Launch Your Rocket

Once you have crafted your launcher and a rocket, it is time to launch.

Put on your safety glasses!

- Slide your rocket over the stick in the bouncy ball.
- Drop the launcher with the bouncy ball facing the ground.
- Try dropping it from different heights.

## Explain and Expand

Have students share their bouncy rockets with the class.

Here are a few questions to ask:

- What can you do to make the rocket tumble more? Less?
- What will happen if you make a really long rocket? A really short rocket?
- What other items might you add to the rocket to make it more stable?
- How could you make the rocket more aerodynamic?
- What challenges did you face while making your rocket?

## Evaluate

Here are a few questions to ask during reflection:

- Where should you add weight to make the rocket more stable?
- Where will adding the weight make it tumble the most, or land on its bottom every time?
- How does the number of fins affect the flight of the rocket?
- What functions would your rockets perform?

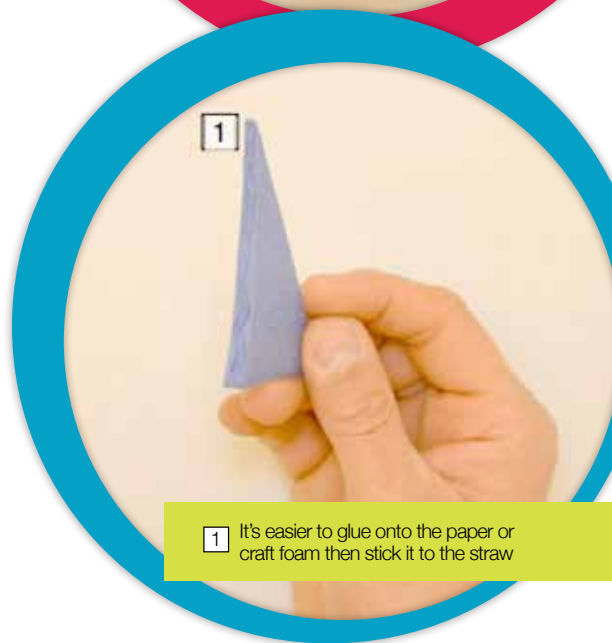

**1** It's easier to glue onto the paper or craft foam then stick it to the straw



Full online instructions for this activity can be found at:  
[www.instructables.com/id/Bouncy-Rockets](http://www.instructables.com/id/Bouncy-Rockets)



## ACTIVITY 2: OZOBOTS IN THE CLASSROOM

Program a  
real robot  
using only  
markers  
and your  
imagination.

### SUPPLIES

- **Ozobots** - Starter packs and classroom kits can be found at <http://ozobot.com>.

THESE ITEMS COME WITH THE OZOBOT:

- **Markers:** To program the Ozobot, you will need black, red, green and blue. The Ozobot will follow a line of any color.
- **Micro-USB Charger:** This comes with the Ozobot and charges on any standard USB port.
- **Code Sheet and Calibration/Tips Sheet** (See appendix)
- **Additional Markers:** If you would like more markers, broad line Crayola markers work well.
- **White Paper:** Larger paper gives you more room to code and draw.

**Time Needed:** 1 class period  
**Grade Recommendation:** K-12

### Engage

To introduce Ozobots to students, ask them to describe a robot, or share what they think a robot is. How might someone program a robot? What uses do robots have? How do robots interpret instructions? What functions do robots serve in the modern world?

### PLAY A GAME

Programming a robot correctly is very important. While humans are able to decipher instructions easily, robots are not good at this. They need very clear, precise instruction. To show this, play a game where you pretend to be a robot.

- Stand furthest from the exit of the room, and place obstacles in the way.
- Ask your students to guide you to the exit using only the instructions forward, backward, left, right, and stop.
- Have one participant at a time give you a command, and follow their command as literally as possible - ham it up!
- You can introduce the unit of steps to the commands (take two steps forward, for example).
- Have participants go around the room giving instructions until you are successfully at the exit.

An Ozobot is a line-following robot. Students can draw a course for the robots to follow and encode tricks or deviations from the design within the lines. Ozobots are a great tool to teach kids about programming, communication, robotics, and providing detailed and concise instructions to others. Ozobots are accessible, have many entry points, and reward the student no matter their skill level.



## Explore

### TEST YOUR OZOBOT

- Draw a line - about 1/4" or 6mm thick - on a white sheet of paper.
- Turn on the Ozobot (the power button is near its left "ear").
- Place the Ozobot on the line, and it will follow it to the end.
- Draw a few lines to get familiar with what thickness of line is best for the Ozobot.
- Use different colors for the line - how does the Ozobot respond to the different colors?

### PROGRAM THE OZOBOTS

To code the robots, simply generate a sequence of colors within the line that the Ozobot is following. The codes are indicated on the Code Sheet that accompanies the Ozobot kit, and can also be found in the appendix.

Have students start with the "Speed" and "Cool Moves" codes. Students will draw lines and incorporate the color code into the line. Test the Ozobot to see how it works! What can they make their Ozobot do?

## Explain and Expand

Have students share their Ozobots with the class. Here are a few questions to ask:

- How do you think these robots work?
- What uses might they be put to?
- Do any of you have a robot at home (Roomba, etc.) that you use regularly?
- If you could build and design any kind of robot, what would it be?
- What challenges did you have while working with your Ozobots?

## Evaluate

Here are a few questions to ask during reflection:

- What uses might these robots be put to?
- What benefits do robots provide to society?
- How do you think robots will be different in the future from what we see today?



**POINTER:** Ozobots are very particular about how the codes are drawn. Students may require coaching on how to correctly replicate the width and length of the color codes. It may be challenging for kids to accomplish right away. Remind them that with practice, they can achieve it.



Full online instructions for this activity can be found at:  
[www.instructables.com/id/Ozobots-in-the-Classroom](http://www.instructables.com/id/Ozobots-in-the-Classroom)



## ACTIVITY 3: ZIPLINE RACERS

# Make a propeller-powered machine that zooms down a string!



**Time Needed:** 2 class periods  
**Grade Recommendation:** 5th-8th

## SUPPLIES

- Regular size popsicle sticks
- Rubber bands #117B (7" long)
- Hot glue and glue guns
- Large paperclips. Vinyl-coated paperclips create the least friction.
- 5" or 6" hook-nosed propellers (available at most hobby stores, or at Kelvin Educational, kelvin.com).
- Fishing line or kite string
- Paper or craft foam
- Masking Tape

PER SMALL GROUP:

- Timers
- Measuring tape
- Paper and pencil
- Calculators

## Engage

Ask students what they know about ziplines. Can they describe what a recreational zipline is? What is powering the person in a zipline? Can students define propulsion?

Gravity powers recreational ziplines. We will use propellers that are spun by rubber bands for our propulsion. How does a propeller work? It spins-pulling the object through the air-or forces air over a wing that provides lift. It's helpful to equate the motion of the propeller to how your arms pull your body through the water when you are swimming.

## Explore

### BUILD THE BASE

- Start by gluing two popsicle sticks together. Thickly wrap masking tape to one end, where the propeller will fit over.
- Mount the propeller over the masking tape. It can be glued if students are only making one zipline.
- Glue a third stick halfway onto the back of the two sticks, opposite where the propeller is mounted.
- Glue a fourth stick onto the other side of the last stick. This will make your zipline base about 8".
- Bend a paperclip into an "L" shape, and hot glue it on the very end of the craft stick opposite the propeller (use a lot of glue). Once the glue is hardened, wrap with masking tape for extra strength.
- Hook a rubber band into the hook of the propeller, then onto the protruding part of the paper clip. Make sure the hook of the propeller and the paperclip hook are on the same side of the base.

**POINTER:** Wrap the joints where the paperclips are glued for extra strength, and do this for any other high-stress joints if the zipline seems flimsy.





Propeller-powered ziplines are a great entry point into flight and propulsion using simple and cheap materials. Students will explore the concepts of physics of flight and propulsion, kinetic and potential energy storage, and the challenges of engineering structurally robust components. Students can also determine the speed of their racer by timing its flight and measuring the distance.

## BUILD THE TOP

Now that the base is complete, your students can build the top any way they would like. As with most making and tinkering, students' imagination and individual design ideas should guide them. Here are a few tips:

- Build the top high enough so that the propeller doesn't catch the zipline (at least 3-4" tall)
- There must be at least two attachment points for your paperclips to hang the device from the zipline.
- Triangles are stronger than squares.

## TEST AND IMPROVE

Give your zipline a test. Lash a piece of string (around 20-30 feet) between two solid structures at least three feet above the ground. Keep the string taut, like a guitar string.

- Wind the propeller in place by turning the blade clockwise as you are facing the front of the zipline.
- Ensure that the zipline is clear all the way down and hang your racer on the line by the hooks.
- Stand aside and release your device. Keep clear of the propeller. Wow!
- Try adding paper or foam to the middle of your zipline racer. How does it change the flight? Decorate your creation.

## MEASURE THE DISTANCE, FLIGHT TIME, AND SPEED

Break into small groups and give your students a challenge: Find a ways to measure and calculate the speed of the zipline racer. Give each group measuring tape, timer, paper and pencil, and a calculator. Here are some things to consider:

- How does the number of times you wind the propeller affect the speed?
- You will need to know the distance the racer travelled.
- $\text{Speed} = \text{time}/\text{distance}$ . Measurements units are important (feet per second, for example).
- Try converting your speed into miles per hour! Wow, that is fast!
- Use the Zipline Speed Calculator worksheet in the appendix to record and calculate this data.

## Explain and Expand

Have students share their zipline racer with the class. Here are a few questions to ask:

- How does changing the weight, amount of rubber band windings, etc. change the speed of the racer?
- What does adding paper to the racer do to its aerodynamics?
- How can you build a faster zipline racer? A slower one that carries weight?
- How would you modify your design to achieve a different metric (faster, smaller, etc.)?
- What problems did you encounter when making the zipline? How did you overcome those challenges?
- What different materials might you use to make your zipline behave differently?

## Evaluate

Here are a few questions to ask during reflection:

- How do different racers fly? How does the design of these racers induce these different outcomes?
- What did you learn while creating the zipline racers?
- What are the uses of ziplines? How could your creation be used in real life?
- How could you create a slow, safe zipline device?
- How would you create the fastest zipline racer?

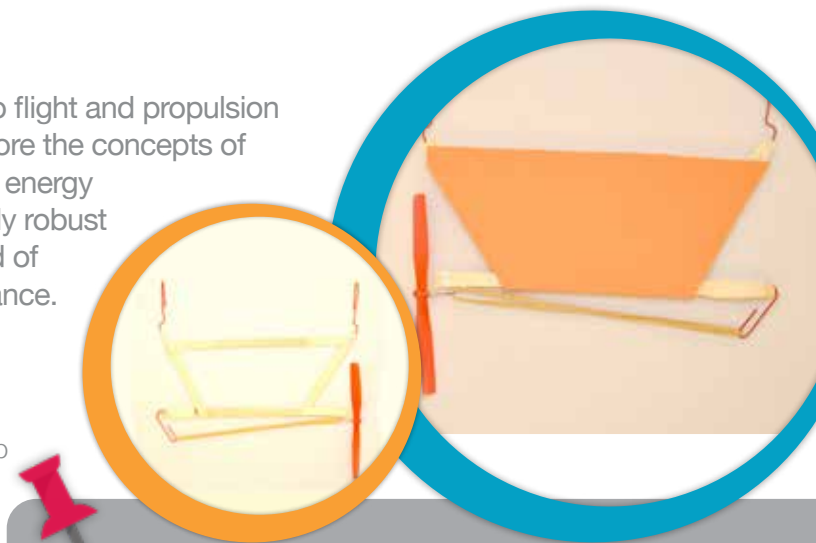

**POINTER:** It's important that there is at least a couple of inches between the top of the propeller and the string or the blade of the propeller will become wrapped in the string when launching! Also, keep fingers out of the blade after releasing the zipline.



Full online instructions for this activity can be found at:  
[www.instructables.com/id/Zipline-Racers-Detailed-Instructable-Remix](http://www.instructables.com/id/Zipline-Racers-Detailed-Instructable-Remix)



## ACTIVITY 4: HOVERCRAFTS

**Time Needed:** 1 class period  
**Grade Recommendation:** 3rd-8th

### SUPPLIES

- **CD** - any old used CD or DVD will work. You can also pick up packs of blank CDs at most electronics superstores
- **Film canister or 1/2" PVC pipe** - film canisters can be found at most photo developing stores for free
- **Large balloon (9" or even 12")**
- **Hot glue gun and hot glue**
- **Large tack or small nail**
- **Pipe cleaners**
- **Craft sticks**
- **Paper, scissors and markers**
- **Tape** - masking tape is best
- Optional: Balloon pump with vinyl tube or flexible 3D printed adapter attached

### Engage

Try sliding just the plain CD across a smooth surface such as linoleum floor or desk. It kind of slides, but there is a bit of resistance. What is that resistance? We call it friction. What goofy things would happen in our world if there was no friction?

We are going to make a device called a hovercraft that reduces the friction between the CD and surface by pushing air into it. The hovercraft rides on a cushion of air that is really thin and can travel much further and faster when we reduce this friction.

### Explore

#### BUILD THE BASE

First, you'll need to build the base of your hovercraft. Take the lid off the film canister - you can save it for other projects or dispose of it. Put a little glue on the open end of the film canister and stick it to the CD, trying to center it over the center hole in the CD.

At this point, there isn't a good seal at the bottom of the film canister, so some air could escape out the sides. Add a good bead of hot glue around the rim of the film canister to completely seal it up. Allow the glue to cool completely before going on to the next step.

#### MAKE VENTS FOR THE AIR

For the hovercraft to work well, air will need to flow below the CD. Poke some holes in the film canister with the tack, being careful not to poke your fingers. It's easier to add more holes than take them away, so try a few and add more if you want.

**POINTER:** Don't get hot glue on the bottom of the CD, or else it will hang up when you're launching! If you are already mostly done, simply glue another CD to the bottom. How will the added weight of the CD change the flight of the hovercraft?



# Design a hovercraft that floats along smooth surfaces.

Students explore the principles of friction and air pressure by creating a simple hovercraft using household items. This is certainly an activity that students can take home to share with their friends and family. Additional engineering challenges, such as making a hovercraft that carries a load or keeps the balloon upright, add to the complexity of this activity.

## ATTACH BALLOON AND TEST

Get a balloon and stretch it over the top of the film canister. This can be difficult for younger groups or those who don't have a lot of hand strength, so they may need help. You can blow up the balloon through the bottom hole of the CD by either blowing through it with your mouth or attaching the balloon pump. Try out this first iteration of the hovercraft. Are there any leaks? How well does it float and move?

## IMPROVE AND ITERATE

Now it's time to build a better hovercraft! Think of a way you can improve the design and support the balloon from flopping around. A simple solution is a band of construction paper, but experiment with popsicle sticks, pipe cleaners, beads, or other materials.

## Explain and Expand

Have students share their hovercraft with the class.

Here are a few questions to ask:

- How does changing the weight of the hovercraft change its float?
- What problems did you encounter when making the hovercraft? How did you overcome those challenges?
- What different materials might you use to make your hovercraft behave differently?
- How does the number of holes in the film canister change things? Does the hovercraft float longer with more holes, or travel further, or is it the opposite?

## Evaluate

Here are some questions to ask during reflection:

- How would you modify your design to achieve a different metric (faster, smaller, etc.)?
- How are hovercrafts used in industry, the military, or for recreation?  
How are those hovercrafts different from the ones we made?
- Can you think of other materials than the CD to make a hovercraft out of?  
What about propulsion sources other than a balloon?
- What would happen if we used a bigger disc? Would the balloon we used be able to lift it?
- What other things can you think of that use air flowing between them to reduce friction (air hockey tables, manufacturing, heavy load lifting, etc)?



Full online instructions for this activity can be found at:  
[www.instructables.com/id/CD-and-Balloon-Hovercrafts-Engineering-Challenge](http://www.instructables.com/id/CD-and-Balloon-Hovercrafts-Engineering-Challenge)



## ACTIVITY 5: LIGHT PLAY

# Tell a story using light & shadows!

**Time Needed:** 1 class period  
**Grade Recommendation:** K-12

### Engage

There is a lot of science to be learned in this activity! Asking the kids where light comes from and what light is, and talking about the electromagnetic spectrum is a great way to introduce this activity. Outside, the light comes from the sun - shadows are cast by something blocking the sun. Depending on the angle of the sun in relation to the object, the shadow will be longer or shorter. Indoors, lights are used to create shadows. If you have multiple light sources in this activity - what happens when the two lights are far apart? Close together?

Terms to introduce are transparency (most light travels through the material), translucency (some of the light travels through the material), and opacity (little or no light travels through). Objects can be opaque to certain wavelengths of light, but transparent to others - radio waves will travel through our bodies, but visible light will not. Reflection (how light bounces off something) and refraction (how light bends when traveling through something) are also good concepts to explore here.

## SUPPLIES

This activity does take some preparation in terms of making or assembling the studios, but once those are finished almost anything can work as a prop.

- **Light Play studio** and **1-2 lights** - one studio works well for a group of 4-5 students.
- **Cloth or ribbon** - mesh with a pattern looks cool.
- **Masking tape**
- **Transparencies** and **dry erase markers** - these work great for creating slides or drawing pictures
- **Solid objects** or **card stock** to create solid silhouettes
- **Dichroic film** - this is a really dynamic iridescent film that changes color based on the angle of incident light, and it's used in making jewelry and small kits of colors are available through places like Etsy or on Amazon



Students will work in groups to take everyday objects and place them in front of an LED lamp to create colorful, creative scenes projected on a translucent screen, learning about the properties of light and shadows. This is a fresh take on the idea of a diorama, and each group is encouraged to tell a story about their scene.

Making and tinkering can sometimes be pigeonholed into describing learning about circuits or 3D printing or designing small craft projects. But sharing stories and engaging in our whimsical and playful nature is also important!



**POINTER:** Don't limit the kids to the props at hand - have them draw and cut out some from paper, use classroom items or bring things from home for a show and tell theme.

## Explore

### CREATE A STORY

Have the students work in groups of 3-6 and spend at least 30 minutes developing a story to share with the class at the end.

Keep the lights on for the first 10-15 minutes, then turn them off so the kids can explore what the scenes will look like when it is dark. Alternatively, have 10 minutes on to work, 5 off to see how their studio will look in the dark, 10 more minutes of light, 5 of dark, etc.

The most important idea to get across in preparing students for this activity is to encourage them to create a scene that tells a story or expresses an idea. For reticent students or those that get stuck, a prompt can be helpful. Something like, "What do the northern lights look like?", "Tell us about how your route to school looks during a certain season.", "What do you think the desert looks like?"

When each group is ready to present, gather the class together and have them visit each studio to hear the story and see the studio presentation of their classmates. This part should be done with the lights off entirely!

## Explain and Expand

Have students share their stories and scenes with the class.

Here are a few questions to ask:

- What is a shadow? How are shadows created? How is this different indoors vs outdoors? What about when the lights are off in the classroom?
- How many shadows are made on the screen when you add a second light into your studio? What would happen if you added a third?
- Can you explain the difference between opaque, translucent, and transparent?
- How can you make shadows larger and smaller on the screen? Why does this work?
- What do you think makes the dichroic film change colors of light so much just by being flexed and bent?

## Evaluate

Here are a few questions to ask during reflection:

- Could you make something like these light studios at home? What would you need to do this?
- What are some things you can think of that would cast an interesting shadow?
- Can you tell what something is just by looking at its silhouette? What about if it changes profile/orientation or proximity to the screen?
- How do our eyes see light? What other kinds of light are there besides visible light?

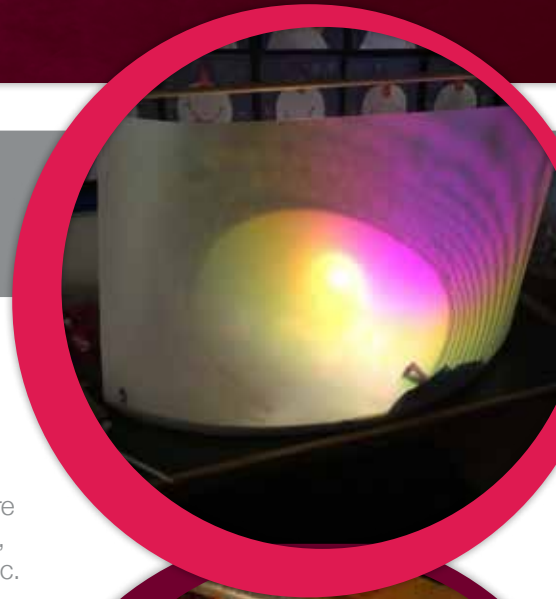

Full online instructions for this activity can be found at:  
[www.instructables.com/id/Light-Play-Studios-in-the-Classroom](http://www.instructables.com/id/Light-Play-Studios-in-the-Classroom)



# Make interesting creatures that light up using play-doh.

## SUPPLIES

- **Play-doh** (homemade or store-bought)
- **9-Volt batteries**
- **Alligator clips or wires or 9V battery snaps** (Digi-Key part#BS6I-MC-ND, digikey.com)
- **LEDs** - the larger 10mm variety are great (Evil Mad Scientist Ultra-Bright 10mm, evilmadscientist.com) but any regular 3V LED will work
- **Paper, craft foam, wood, plastic, etc.** - anything that is an electrical insulator will work
- **Pipe cleaners or insulated wire** (16-20 AWG would be fine)
- **Optional:** 3V piezo buzzers, vibrating motors, or any other exciting component that is safe that operates at 3V
- **Optional:** it is helpful to solder and/or crimp male disconnect terminals to the leads of components like the battery snaps, motor and buzzer wires

## Engage

Circuits work because of electrons flowing through them to complete a full loop, which is a complete circuit. They flow when there is a difference in electrical potential between two points, which we talk about as charge. If there is a more positive charge, the electrons will flow towards it to try and achieve equilibrium.

We'll be creating circuits out of conductive materials and using insulators to get the electricity to flow where we want it to. This is a good way to engage the students about the class of materials we call electrical conductors and their counterpart, insulators. Conductors of electricity are materials that electricity will readily flow through - this includes materials like metal and water that have electrolytes them. There are more exotic things like graphene sheets and such, but these two classes cover a large part of what kids will be familiar with when it comes to conductors.

Insulators are materials that electricity does not easily flow through. There are many more different materials that are insulators than conductors, so challenge the kids to come up with the goofiest insulator. Wood, paper, rubber, plastic, fabric and glass, etc. are all insulators.

## Explore

### HOOK UP THE BATTERY

Once you've gathered your materials, get out some play-doh and make two balls about the size of a golf ball. Attach either two alligator clips to the battery or the battery snap. Pay attention to which clip is the positive and which is the negative - polarity is very important for these circuits! Once your battery is hooked up, stick one of the leads into one of the balls of dough, and the other in another ball. You have a partial circuit here, but we need to close the loop by adding a component.

**Time Needed:** 1 class period  
**Grade Recommendation:** 3rd-8th

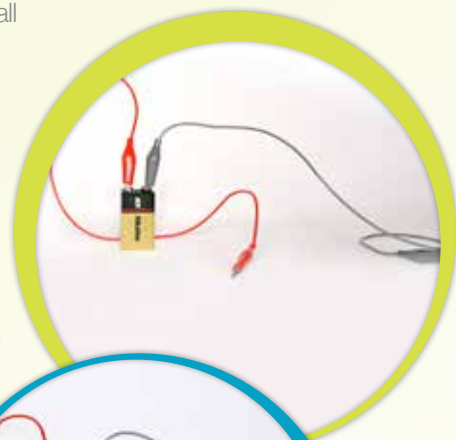

Conductors, insulators, and resistance are all central to this innovative exploration of electric circuits. Participants create sculptures using play-doh (which is conductive), wires or pipe cleaners, and a variety of insulators. Each creature incorporates an LED or buzzer, challenging the artist to create a design that doesn't short-circuit.



**SAFETY TIP:** There are two important safety considerations to address with this activity. The first is that if you short the 9V battery for too long, it will overheat and start smoking. DON'T leave two balls of play-doh with the leads connected touching each other for too long - this is a short circuit and will overheat the battery. Also, DON'T touch the legs of the LED directly to the alligator clips or the terminals of the battery. LEDs use 3V to operate, and our battery puts out 9V. If you do this, the LED will burn out and could potentially explode when heated.

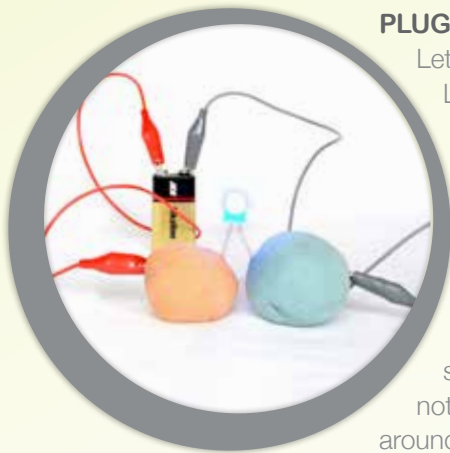

### PLUG IN AN LED

Let's learn how to "plug in" the LED properly to our circuit.

LED stands for Light Emitting Diode. A diode is an electrical component that only allows electricity to flow in one direction through it. When electricity is flowing the proper direction through an LED, it lights up! When it is flowing the opposite direction, nothing happens. So, how do you tell? LEDs have two legs on them: the longer leg is the positive lead, and the shorter leg is the negative. So, make sure that the long leg of the LED is connected to the positive ball of play-doh, and the shorter is connected to the negative. If you plug in your LED and nothing happens or you can't tell which leg is longer, simply turn it around to see if this is the problem.

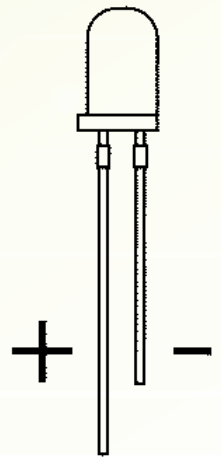

The picture above shows the LED working and properly connected for this test circuit.

### HOW DOES THIS WORK?

Why does our LED that likes 3V not explode when connected to the play-doh, but gets damaged if hooked up directly to 9V? Well, the play-doh is conductive because of the water and salt in it, but it does not conduct all of the 9V to the LED. All conductors have a little bit of electrical resistance: some of the current that flows through the LED is resisted by the play-doh. There are other ingredients in there like flour, oil, and cream of tartar that are insulators, so play-doh has a relatively high resistance as compared to copper or just a cup of salt water. When the electricity flows through the play-doh, the resistance of the material brings the voltage down to 3V for the LED, and everyone is happy.

To dig a little further into this, push the two balls of play-doh together once your LED is lit up. (It's okay to do this for a short time.) The LED will go out, as shown above. It's helpful to tell kids that electricity is very "lazy" - it will take the easiest way it can to make a completed circuit. When the two balls are separated, there is technically an insulator in between them - air. To complete the circuit, the electrons have to flow all the way up through the LED, light it up, and go back down into the other ball of play-doh. When the two are pushed together, the electrons can flow easier through the play-doh vs the LED, so they do that instead. They take a shorter path to complete the circuit, which is why it's called a short circuit.

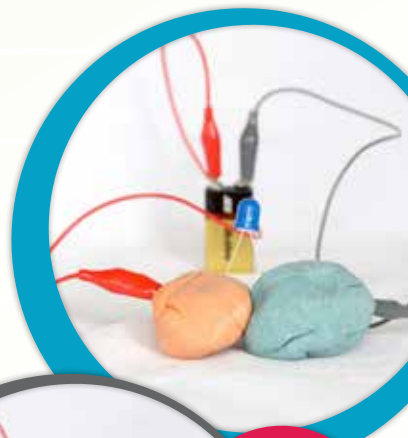

## ACTIVITY 6: SQUISHY CIRCUITS

If you put a piece of paper, wood, foam, etc. in between the balls of play-doh and push them together, your LEDs will still light up. Try adding more LEDs to the circuit - what happens to the brightness of each LED as you do this?

Lastly, most items that are insulators are really just materials that have a high resistance to electricity - electricity can still travel through them, but it takes a lot more current to overcome the high resistance of the material. This means that electricity can travel through air (think of lightning and static electricity) or melt through the insulation on a wire, it just has to have a lot of current.

### MAKING MORE COMPLICATED CIRCUITS AND CREATURES

Now that we've got the very basic principles down for this, it's easy to expand to make more complicated circuits or experiment with other components. Try the piezo buzzer - what happens if you plug it in with reverse polarity? What about a motor?

The pipe cleaners are another great additional tool for this activity - they are essentially an insulated wire with fluffy plastic on the outside and flexible steel on the inside. You can use pipe cleaners to jump between balls of play-doh. If it's not working, strip some of the fluff off of the ends of the pipe cleaner. Remember, though, that you always have to have a ball of play-doh to plug into or you'll be putting 9V into the LED.

The best part of this activity is making your own creature - we've seen everything from snakes and ponies to castles to hamburgers with red LED ketchup!





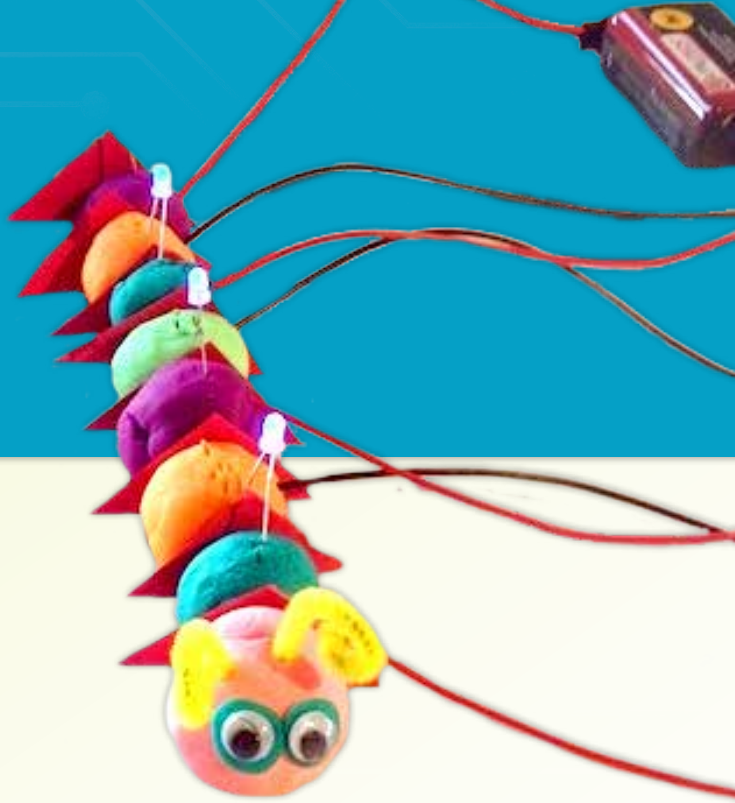

## Explain and Expand

Have the students share their creatures with the rest of the class. Here are a few questions to ask:

- What is a circuit, and what does it mean for a circuit to be open or closed?
- What happens when you add more components to the circuit? Why?
- Why do you think a battery will overheat when short circuited?
- What things do you need to create the simplest circuit you can think of? What about a more complex circuit?
- What other materials like play-doh do you think would work for this activity? Bananas? Pickles?
- As these circuits are left connected for a bit, the negative terminal tends to get a black film on it. Why do you think this happens? (Hint: it has to do with the salt content of the play-doh and the process of electrolysis)

## Evaluate

Here are a few questions to ask during reflection:

- How many balls of play-doh do you think you could hook together before the resistance would be too great to complete the circuit?
- How is it that static electricity can travel through the air (shocking your sibling or friend right before you touch them directly, for example) when air is a resistor?
- What is resistance in a circuit?  
See image at right for a graphical illustration of Ohm's law as it pertains to volts, amps, and ohms.

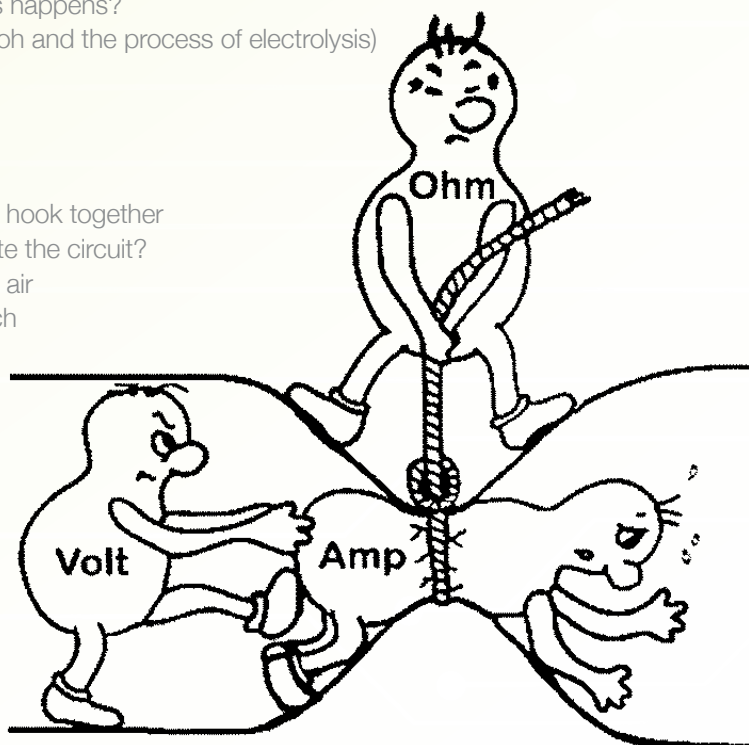

FULL ONLINE INSTRUCTIONS for this activity can be found at:  
[www.instructables.com/id/Squishy-Circuits-in-the-Classroom](http://www.instructables.com/id/Squishy-Circuits-in-the-Classroom)



## ACTIVITY 7: MAKEY MAKEY

Anything conductive can be a computer key with this award-winning circuit kit!

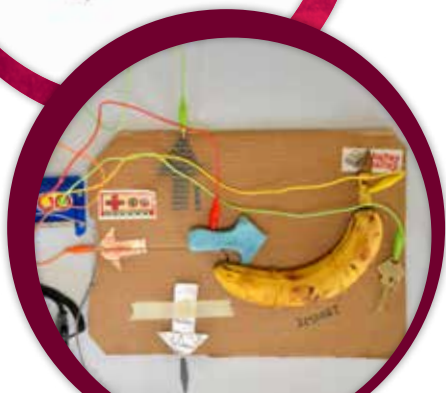

## SUPPLIES

You don't need much to make this activity work, but it's helpful to have a variety of items on hand.

- **Makey Makey Kit** - comes with 7 alligator clips, Makey Makey board, USB cable, jumper wires, & instructions
- **Conductive materials** - anything conductive will work, really.
- **Bananas** (though celery is a better option that doesn't get as gross)
- **Copper tape** - if it's an option, get the conductive adhesive version (Sparkfun part# PRT-13828, sparkfun.com)
- **Graphite** - artist's pencils type 6B are best, but No. 2 pencils are okay
- **Aluminum foil**
- **Play-Doh** - homemade or store bought
- **A friend or classmate** (more on that later)
- **Insulators** like paper, cardboard, masking tape, etc.
- **A computer with a USB port and working internet connection** or Scratch installed and no internet
- **Optional: ESD** grounding bracelet to attach to your wrist for the ground connection. You can purchase one of these or simply make your own with an alligator test lead and some aluminum foil.

**Time Needed:** 1 class period

**Grade Recommendation:** 2nd-12th

## Engage

Makey Makey is an incredibly fun and innovative tool for teaching kids about conductivity and electric circuits. It is very easy to set up and play with, while also being incredibly versatile and encouraging experimentation and play.

While these instructions will focus on using Makey Makey to create a controller for playing video games, there are many other uses and all sorts of creative devices that it can be used in to interact with a computer. Think of what you might create on your own!

How Makey Makey works is simple: the board is sending out a small amount of electricity on the different keys, and when the circuit is completed between that key and the ground bar, it tells the computer that that is a key press. The beauty of the design is that you can use anything conductive to achieve this - bananas, play-doh, metal, other people, etc.

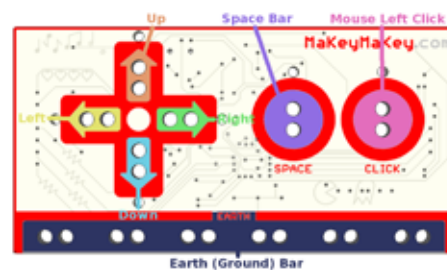

## Explore

### HOOK UP AND TEST

Before making a controller, it's helpful to hook everything up and test it out to see if it will work.

Simply plug in the USB cable to an available port on your computer, and plug the other end into the Makey Makey. These use the drivers for generic keyboards and mice, so there are no programs to install.

If you have issues with connectivity, see the Makey Makey quick start guide for details.

Go to the Makey Makey Apps website (<http://www.makeymakey.com/apps>) and pick something simple like Bongos. You can either hook up test leads to each of the directions and keys (Up, Down, Left, Right, Space, Click) or just press them with your fingers. Here's where the circuitry comes in - the bar on the bottom of the board is the Earth (Ground) Bar. To complete a circuit for the Makey Makey to register a key press, you have to connect one of the keys indicated above to the ground bar. So, hold the ground bar and just touch the Left button or Space with the Bongos app and it will play one of those two sounds. Yay, everything is working right!

Even another person can be one of the buttons on your keyboard. High fives are a great way to do this, with one person holding a lead attached to a key, and the other holding a lead attached to the ground bar.

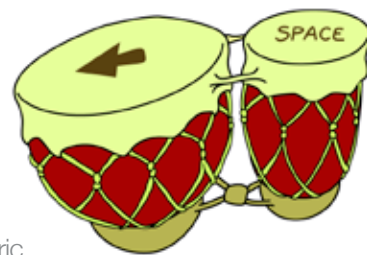

With a blend of digital and low-tech items, participants create a computer controller using items that are conductive. This controller can interface with simple games like Mario Bros. or Tetris, make music, control a camera, and much more.

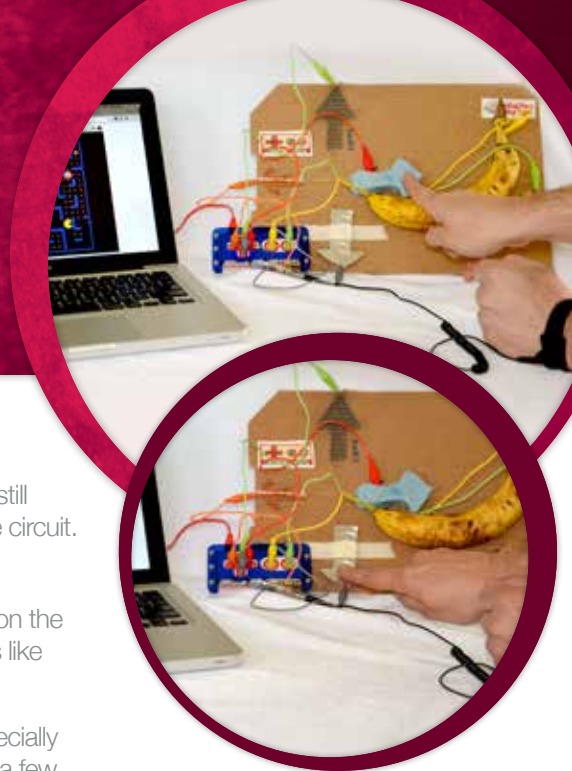

A great activity to do with a large class is to get them all to stand in a circle and hold hands. One person on one end of the circle touches a key, and on the other end the person touches the ground board. The most we've done is 32 people, and everything still worked fine! In this scenario, the electricity travels through each person to complete the circuit.

### MAKE A CONTROLLER AND GET PLAYING!

Now it's time for the real fun - making your own controller for a game. All of the games on the Makey Makey Apps site are kid-friendly and optimized for the Makey Makey, but others like Dance Dance Revolution, Mario Brothers and Pac-Man work well too.

It is recommend to mount your controller on a piece of paper or cardboard. This is especially important if you are working on a metal surface so you don't get a short circuit. Having a few cardboard boxes on hand is a great way to add some variety to this activity - instead of a 2D mounted controller, make one that is 3D.

It's also helpful to label which items press which key, as it's hard to remember if you're in the middle of an intense game of Pac-Man if the banana is up or down, or if a ball of aluminum foil is left or right.

The possibilities of controller design are endless, so don't prime the students to make one exactly like the one shown above. It can be a hat, a box that has a metal ball rolling around in it, etc.

**POINTER:** If things are not working, it's likely that one of the test leads has come loose either on the Makey Makey or on the conductor that you've attached it to. Also, it's important to remember that you are completing the circuit, not just pressing the button on the Makey Makey, so the ground bar needs to be a part of the circuit.

If the game you are playing needs more keys than the ones on the front face, you're in luck - the extra jumper cables supplied with the kit can be plugged into the back of the Makey Makey for additional keys. See the image at right for which ones will work.

Lastly, if you are working with kids who are familiar with Scratch, it is very easy to write your own game or Scratch program to interact with the Makey Makey.

## Explain and Expand

Have your students share their controller with the class.

Here are some questions to ask:

- What is a circuit, and what does it mean for a circuit to be open or closed?
- What other materials do you think would work for this activity?  
Pickles? Kiwi fruit? Cheese?
- Sometimes you can trick the Makey Makey into thinking a key has been pressed even though you are not touching ground by building up a good static charge. What is going on here?

## Evaluate

Here are some questions to ask during reflection:

- What is something exotic that you think would work well as a button key?
- What will happen if you attach an insulator to test lead that is connected to the Makey Makey? Will it work?
- Can you think of a non-computer game that you could create using the Makey Makey?  
(Example: a door alarm that alerted someone when a door was opened).

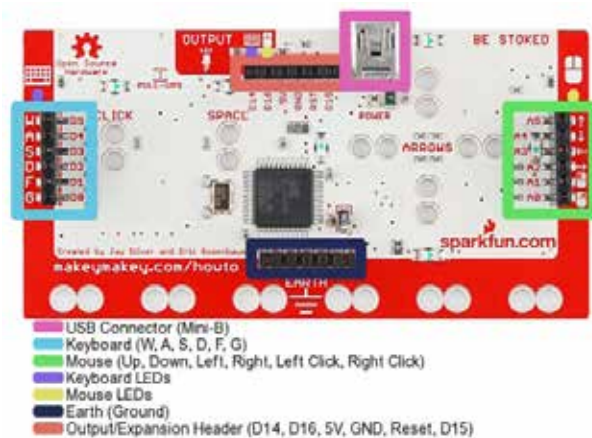

Full online instructions for this activity can be found at:  
[www.instructables.com/id/Makey-Makey-in-the-Classroom](http://www.instructables.com/id/Makey-Makey-in-the-Classroom)

## ACTIVITY 8: CIRCUIT BLOCKS

# Create your own electronic components!

## SUPPLIES

**Time Needed:** 2-3 class periods  
**Grade Recommendation:** 5th-12th

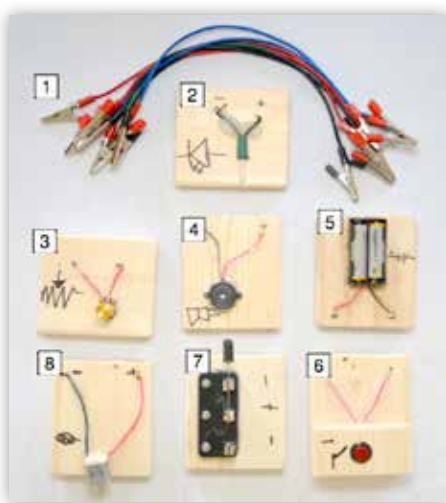

- 1 Alligator clips - any will do, these beefy ones are made to last.
- 2 LED - make sure the + and - are labeled properly.
- 3 Potentiometer - like a volume knob.
- 4 Piezo speaker - make sure this one is internally driven.
- 5 Battery Block.
- 6 Momentary Switch
- 7 Knife Switch
- 8 Motor

You'll need the blocks shown above. Here's a brief description of what each does:

- **Alligator clips** - used to connect each block to other blocks in the set. Any will work. The ones shown were made with thicker gauge wire (16 AWG audio speaker) and larger clips for durability.
- **LED block** - made from a string of LED christmas lights. Ensure that the (+) and (-) legs are labeled properly on this one. LEDs are a diode, which means that the electricity has to flow through them the proper direction: the (+) has to be attached to the positive side of the battery and (-) to the negative side.
- **Potentiometer:** this is a variable resistor. When the resistance is high, less electricity is flowing through the circuit. When lower, more. So, when the volume is turned all the way up on a speaker or speed on a motor, the resistance is lowest. When the speaker has the lowest volume or lowest speed on the motor, the resistance is at its highest through the potentiometer.
- **Piezo speaker** - this is a little buzzer. Make sure to use a piezo buzzer that is internally driven. These, like the LEDs, need to be hooked up with (+) to positive and (-) to negative.
- **Battery:** plain enough, this powers the whole thing.
- **Motor:** a little DC motor. This can be hooked up either direction; changing the polarity of how it is hooked up will change the rotational direction of the motor.
- **Knife switch** - looks like something right out of Frankenstein! These switches are a way to hook up two separate components to the same battery, or just make an on/off switch that stays on/off for a component.
- **Momentary switch:** this is a simple pushbutton switch. When it's depressed, it allows current to flow through the circuit. When it is not pushed, it breaks the circuit. A great setup is to put it in line with a speaker and have the kids make Morse code.

## Engage

Learning about circuits and electricity can be an intimidating task - it seems so complicated! This activity involves the use of a modular set of electronic components that are easy to hook up to each other. The circuit combinations possible with a few of these components are almost endless, and any electronic component that you can glue onto a block of wood will work: take apart some old toys and add some of their working bits to this set, for example.

For full instructions on how to make a set of circuit blocks (or add new ones), visit the Snapguide from Learning Technologies at the Science Museum of Minnesota (<http://snapguide.com/guides/make-circuit-blocks/>)



### SAFETY TIP:

NEVER make a circuit that doesn't have a load on the battery (LED, motor, speaker, etc) - this is short circuiting the battery and will ruin the batteries, potentially causing them to overheat and smoke. It's unlikely they will catch on fire, but it is possible. A switch (momentary or knife) is NOT a load on the batteries. If the batteries do get shorted, disconnect them immediately and set them aside for a bit. If they remain that way for too long, the batteries will become unusable, so throw them away.



Build the tools and parts of a modular electronics set. Explore electricity, circuits, and programming by making a set of electronic blocks – it's like LEGOs for electricity. Students will make sets of circuit blocks in groups of two or three and assemble circuits cooperatively.

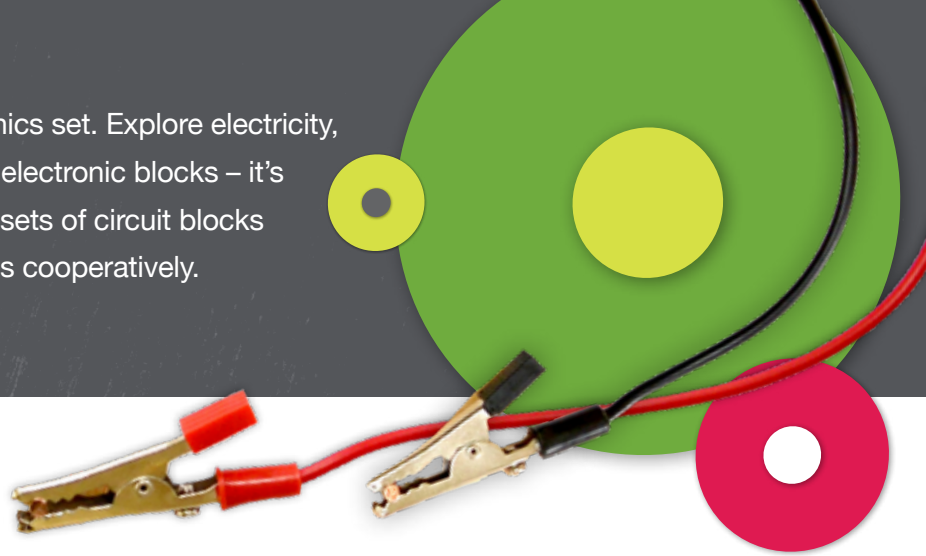

## CIRCUIT SYMBOLS

A great extension to playing around with and building circuits in this activity is learning about circuit symbols and diagrams. Electrical engineers and hobbyists all use circuit diagrams to be able to replicate someone else's circuit - it's a universal way to communicate how components are hooked together. Circuit diagrams scale from showing how to hook up something as simple as a light bulb to as complex as how to build a supercomputer.

Each component should be labeled with the internationally recognized circuit symbol - that way, you can set out a diagram and challenge the kids to set up the circuit using the symbols to see what it does! See the appendix for symbols and diagrams you can print.

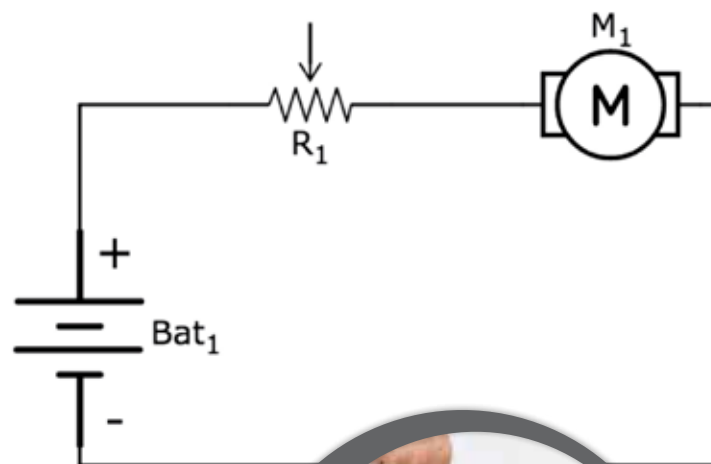

## CIRCUIT 1: BEEP BEEP BOOP

This simple circuit is a great way to get started. A momentary switch and any of the load components (speaker, LED, motor) will allow you to switch on and off the current to the component. Make some Morse code, light up a dance party, etc. Hook up multiple components in line with the battery and see what happens when more of them are powered on.

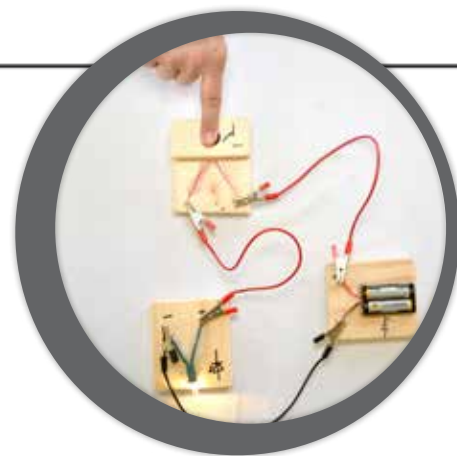

## CIRCUIT 2: PUMP UP THE VOLUME

Play with the potentiometer. This component changes the resistance through the circuit: higher resistance impedes the flow of electricity, making the light dimmer, motor slower, or speaker weaker. Lower resistance allows these components to work at a higher brightness, speed, or volume.

What happens when the resistance is all the way up?

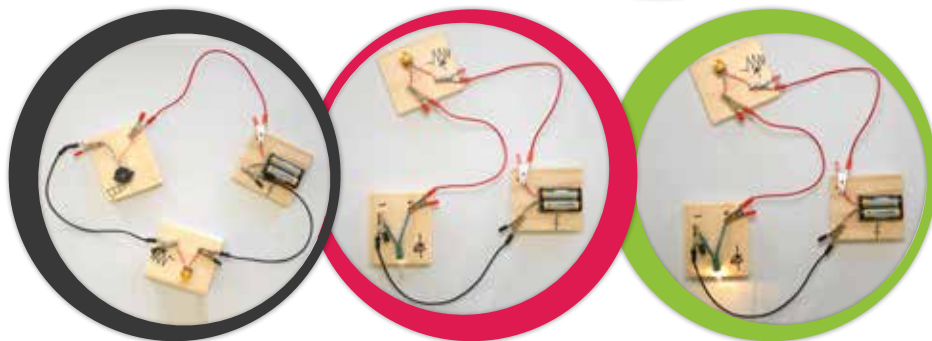

## ACTIVITY 8: CIRCUIT BLOCKS

### CIRCUIT 3: THE KNIFE SWITCH

The knife switch block tends to give kids trouble, and it is not immediately intuitive how to hook it up. Basically, it connects the middle contact to either of the two side contacts. See at right for how to make it power two separate blocks. You can alternate between the two by putting the knife down on either contact. Multiple components can be added in series or parallel on either contact.

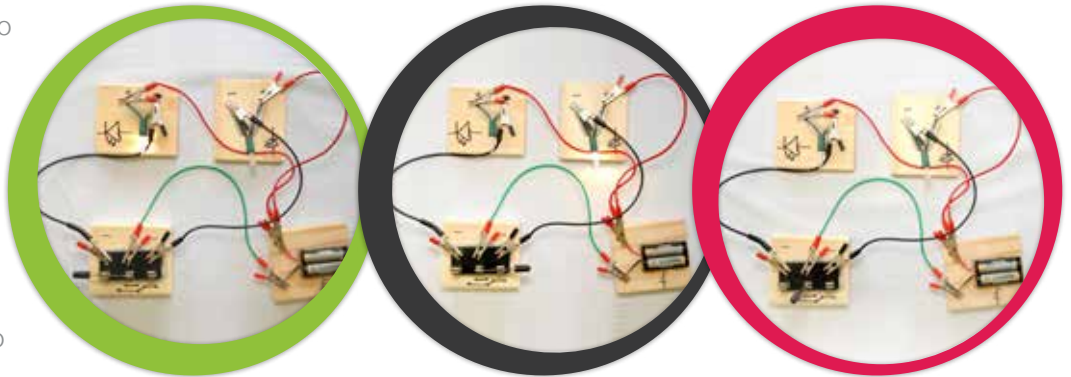

### CIRCUITS 4 AND 5: SERIES AND PARALLEL CIRCUITS

The concept of series and parallel circuits is a fundamental one to get across to kids. How batteries are hooked up to a circuit changes their output voltage and current, which has an impact on how the circuit will behave. The same goes for components: if they are hooked up in series vs. parallel, they will behave differently. The typical example is Christmas lights: old style ones had all the bulbs hooked up in series, meaning that if one single bulb burned out, the whole string would shut off because it is breaking the circuit. You had to go along and find the burnt out one and replace it - a huge pain! Modern lights are hooked up in parallel: each bulb is essentially creating its own circuit with the power source. When one bulb goes out, the rest will stay lit, and it's much easier to find and replace burnt out bulbs.

In the below photos, the batteries are hooked up in series in one photo and parallel in another. When they are hooked up in series, the voltage of each battery pack is added together. Each individual AA battery puts out 1.5 volts. A battery pack has two of those batteries essentially hooked end-to-end in series, so each battery pack puts out 3 volts. If you hook two battery packs up in series, that generates 6 volts, which is too much for the LED and the speaker, but probably okay for the motor. In the example, a potentiometer is hooked into the circuit to limit the voltage to the LED so it doesn't burn out.

When the batteries are hooked up in parallel, the output voltage is the same - 3 volts. However, we added more battery capacity into the circuit, so our LED batteries will last twice as long.

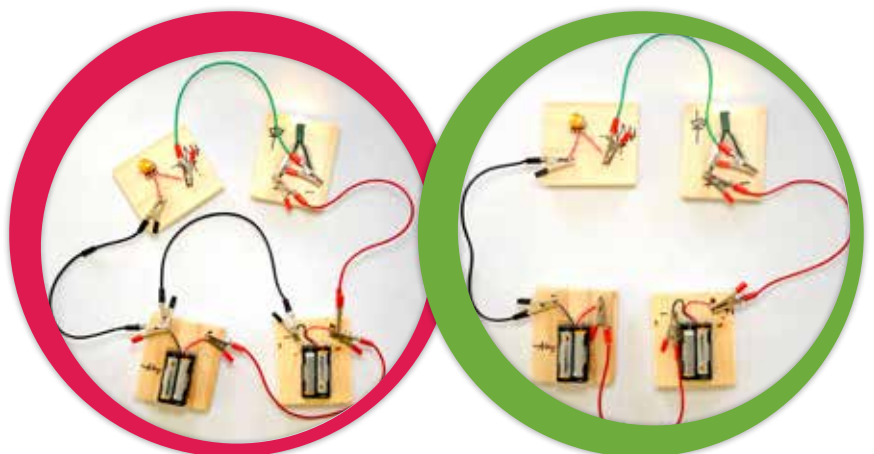

PARALLEL CIRCUIT

SERIES CIRCUIT

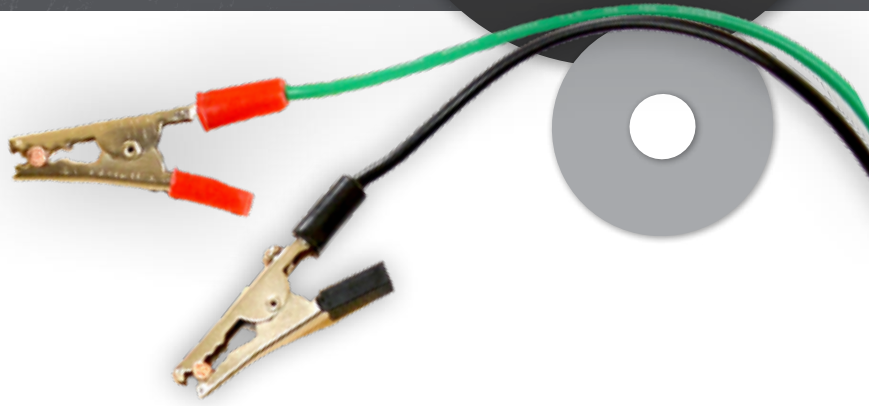

## Explain and Expand

Have the students share the circuits they made with the class.

Here are just a few questions to think about when facilitating this activity:

- What is a circuit, and what does it mean for a circuit to be open or closed?
- What happens when you add more components to the circuit without adding another battery? Why?
- What is resistance in a circuit?
- Why do you think a battery will overheat when short circuited?
- What things do you need to create the simplest circuit you can think of? What about the most complex circuit?

## Evaluate

Here are some questions to ask during reflection:

- What other electrical components would work great as a circuit block?
- How many blocks do you think you could attach together?  
Would you connect them in series, parallel, or a mix of the two?
- Can you create a circuit of your own and draw a circuit diagram so that someone else could replicate it?



Full online instructions for this activity can be found at:  
[www.instructables.com/id/Circuit-Blocks-in-the-Classroom](http://www.instructables.com/id/Circuit-Blocks-in-the-Classroom)

## ACTIVITY 9: FORCED PERSPECTIVE PHOTOGRAPHY

**Time Needed:** 1 class period  
**Grade Recommendation:** K-12th

### SUPPLIES

- The Polaroid Z2300 Instant Print cameras - cell phone or digital cameras work just as well
- Polaroid ZINK refills for the camera
- A photo printer like the Polaroid Hi-Print if you are using a different camera
- SD Card for the camera
- Props of any sort - paper cutouts are great to have kids color or they can draw their own
- If you do cutouts, popsicle sticks and tape or glue are a must so that your hand doesn't show up in the photographs
- A wide open space outside or large interior space (a gym would work well)

### Engage

Forced perspective photography is a great way to get kids thinking creatively and engaged in making fun scenes and stories. They will do amazing things when you hand them a camera (in addition to taking a billion selfies). There is also a lot of math and science content in this activity in terms of thinking about distance, proportionality, and the way our brains perceive the world.

This is a fun and light activity and is best done outside when the weather is nice. It is possible to do inside, but the effect is much greater in a wide open space such as a field or playground.

### Explore

#### HOW TO WORK THE POLAROID Z2300 CAMERA

For classroom facilitations it's very important that you charge the cameras before using them. One downside to these cameras is the printing feature uses a lot of battery, so charge the cameras between each class and during any other breaks if you'll be using them a lot.

See the camera's manual for further instructions, but here's a quick rundown of how to use it and some pitfalls to avoid.

To take photos, turn the camera on using the power button on the top. Ensure that the Playback/Video/Photo button selection switch is underneath the red camera symbol. Get your photo lined up and press the zoom button to zoom in/out as desired. The photo you are taking is shown on the LCD screen on the back. Press the large red button on the top to take your photo once you are ready. Take multiple photos! It would be hard to fill a 2GB SD card in a class period, so take lots of photos to be able to choose the best to print.

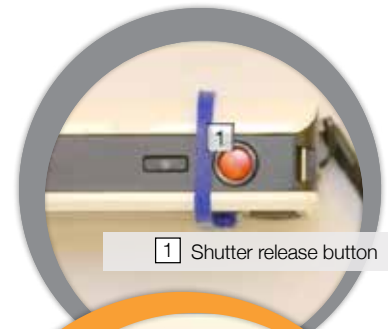

1 Shutter release button



- 1 Wide/Tight Zoom
- 2 Video, playback, photo taking selector
- 3 Menu selection switch and OK button
- 4 Print photo button
- 5 Screen
- 6 3D-Print strap to prevent accidental opening of back

**POINTER:** Make sure that students use the wrist strap at all times, they will definitely drop the camera if they do not!



# Trick your brain while exploring the relationship between distance and perceived size.

Students can print, draw, or sculpt items and place them strategically in front of the camera to tell an interesting narrative or simply make something whimsical. The use of instant-print cameras adds novelty and ensures that all students can participate with or without a smartphone. This activity is a rewarding way to challenge and hone spatial reasoning skills.



Take all your photos at once, then plan to print them at the end of the class period or when you're inside and don't have as much glare on the screen. When you are satisfied that you have a shot or two that will work well to print, push the print button (this works in both camera and playback modes). It will allow you scroll through the photos: select which photo to print by pushing the print button again, and choose how many copies to print (the default is 1). It'll ask if you want to print this one: select OK and it will start the process.

The printed picture will come out of the side. Do not pull on it as it's printing! If the printing takes a long time or the colors are very faded, it's likely the battery is low.

To add more ink sheets, slip off the 3D printed band and push the open button up. The sheets come in packages of 10 with a blue card that tells the camera some calibration aspects of that batch of sheets - it says it is necessary, but it's actually not (though you will get better quality photos if you use it). Additionally, some cameras need to have that sheet primed a little bit to feed through, so push it a little bit into slot on the side nearest the buttons and the camera will do all of the work from there.

When you insert the film package, ensure that the shiny side of the film is facing you. The back is printed with the word "ZINK" all over it. Also, don't put more than 10 sheets into the camera at one time.

It is very easy to accidentally open the back of the Z2300 camera. A thick rubber band or piece of tape will work well to solve this. The indicated 3D-printed strap covers the switch as well as keeps the whole thing closed.

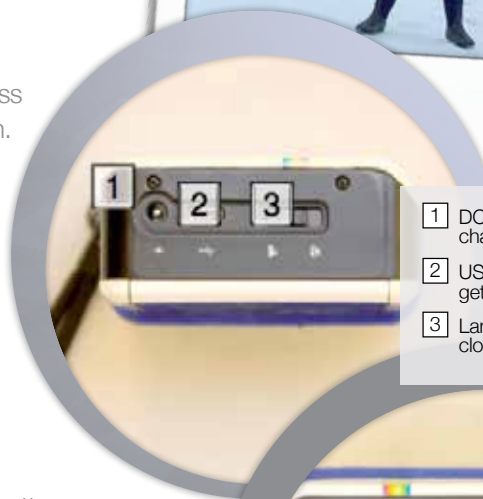

- 1 DC Power jack to charge camera
- 2 USB connector to get photos onto PC
- 3 Landscape vs closeup selection



- 1 Printed photo exit port
- 2 Wrist strap - USE IT!

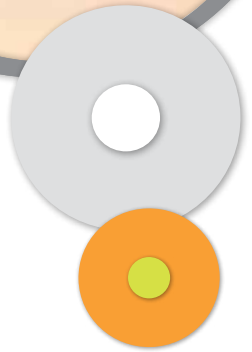

## ACTIVITY 9: FORCED PERSPECTIVE PHOTOGRAPHY



### Getting the Perfect Shot

Setting up your shot is the most important part of forced perspective photography. Really, any photograph that you take in which you use the distance between objects to vary their size in proportion to each other is forced perspective. Important concepts to take away from this activity are foreground, background, and proportionality. If you put something twice as far away as something else, it will look twice as small. The inverse is true as well.

There are other things that affect how you judge distances. Your brain gets clues from how objects overlap, how they interact with the background, or whether things are in focus. Controlling for these things can make the forced perspective trick work better. These are good considerations when thinking about how to compose a shot.

For actually taking the photos, have the kids work in groups of at least 3 - one is the photographer, one student does the foreground work, and the other does the background work. Don't have them get so far away from each other when doing the actual photo taking that they can't hear each other, and have them plan their composition before heading outside to take photos.

**POINTER:** Have the kids take all their photos at once, then print after coming back inside or at a later time.

## Explain and Expand

Have the students share their photos with the rest of the class. Here are some questions to ask during facilitation:

- How do we use forced perspective when drawing or painting something on a two-dimensional surface to give it the appearance of something with depth?
- Why do our brains perceive this size difference?
- What other props might you use to create a scene or story using forced perspective photography? Try it at home!

## Evaluate

Here are some questions to ask during reflection:

- How would this technique be useful in the film and photography industry?
- Can you think of any famous photos or paintings that use forced perspective in their composition?



Full online instructions for this activity can be found at:  
[www.instructables.com/id/Forced-Perspective-in-the-Classroom-with-the-Polar](http://www.instructables.com/id/Forced-Perspective-in-the-Classroom-with-the-Polar)



## ACTIVITY 10: STRAWBEES

**Create a wacky contraption with straws and connectors.** Strawbees are a fantastic activity that foster creativity, engineering and design principals and really engage the sense of whimsy that many students bring to such activities. As one teacher put it, "It's like LEGOs for straws." The most simple building systems are usually the best!

**Time Needed:** 1 class period  
**Grade Recommendation:** K-7th

### Preparation

If you are making your own Strawbees connectors with the die set, it's best done in advance. Cut the plastic into strips about the width and length of the die, then use a die-cut machine to punch them out. You can get multiple punches out of each sheet of plastic or chipboard.

It is helpful to organize the connectors based on their type (single, double, triple, etc). If you are using the large STEAM school kit which can be purchased from Strawbees, the connectors are in separate bags and color-coded, which makes the activity and cleanup much quicker!

### Engage

Introduce the Strawbees and demonstrate how they work. It's helpful to build something in advance to demonstrate what a finished product will look like - good options are the puppy, catapult or grabber arm (see the link to our online Instructable for this activity for a booklet of these designs to download). Ask students what they might like to build. Read a few of the Pocketful of Ideas card deck - they are hilarious!

## SUPPLIES

- Strawbees connectors
- 1/4" plastic drinking straws with bend
- Scissors
- Construction paper
- Hole punch

#### Optional:

- If you have the die set from the manufacturer and a die-cut machine, you can punch your own Strawbees connectors out of recycled plastic or thick chipboard
- A stout pair of scissors is necessary to cut the thick plastic into strips for creating the connectors
- The Strawbees Pocketful of Ideas card deck is useful for kids who get stuck or just for general inspiration

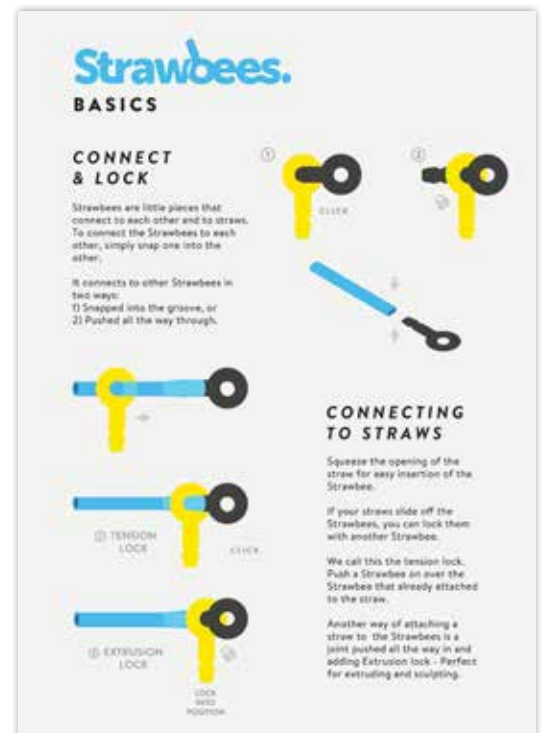

This is a great activity to accompany other curriculum - whether it's designing a bridge to stress-test or recreating elements of a sci-fi novel for language arts, Strawbees lend themselves to many different subjects, or are fantastic as a standalone activity suitable for (almost) all ages.

## ACTIVITY 10: STRAWBEES

### Explore

It can be helpful to establish a theme for the class to build creations within to help those students who might struggle to come up with an idea of what to build. Suggestions from the card deck are another way to encourage creative designs. Give students 20-30 minutes of building time, then regroup to share their designs, ideas, and challenges.



### Explain and Expand

Have students share their creations with the class. Here are a few questions to ask:

- Why did you choose to build what you did?
- What are some other things you might build with these materials?
- What additional materials might be helpful to use when building a Strawbees creation?
- What challenges did you face while making your creation?

### Evaluate

Here are a few questions to ask during reflection:

- How do the different connectors create different designs?
- Can you come up with or draw a connector that has 4 connections or more than 5? What kinds of designs would result from those connectors?
- If we wanted to avoid using straws in this activity, what other things might we try?
- How high do you think you could build a structure with these materials? What would you need to do to ensure it was sturdy?

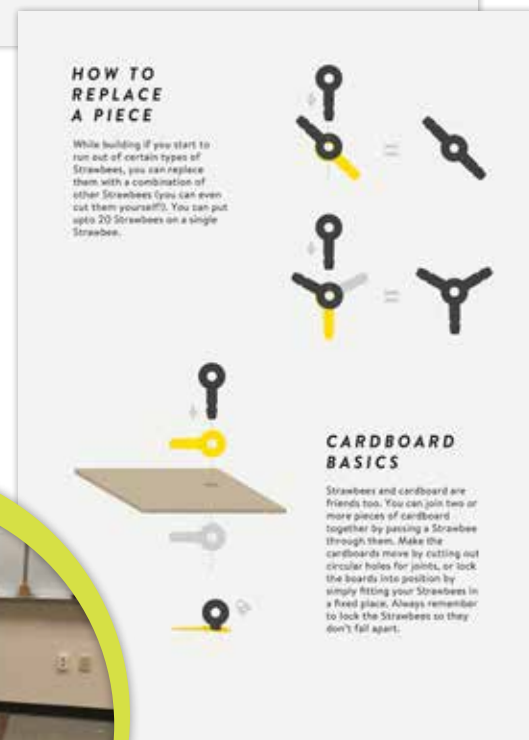
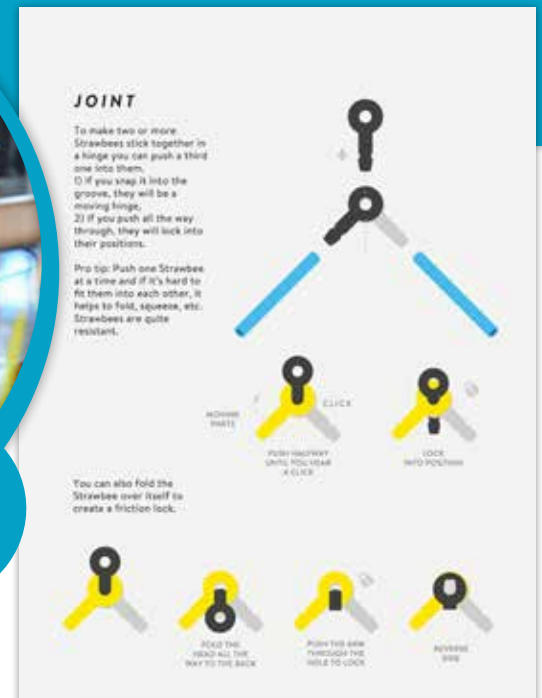

Full online instructions for this activity can be found at:  
[www.instructables.com/Strawbees-in-the-Classroom-or-Makerspace](http://www.instructables.com/Strawbees-in-the-Classroom-or-Makerspace)



# ACTIVITY 11: PAINTBRUSHES AND COCHINEAL PAINTING

Bug out and release your inner artist!

## SUPPLIES

- **Sticks or chopsticks** – enough for 2-3 brushes per student
- **School glue or hot glue**
- **Absorbent materials** (sponges, hair, wool, etc.)
- **String** – cotton or twine works best
- **Mortar and pestle**
- **Cochineal** – the dried insect can be found on Amazon under fabric dyes
- **Multimedia paper for watercolor painting**
- **Alum** – can also be purchased on Amazon
- **Lemon juice or citric acid**
- **Rubbing alcohol**
- **Hydrogen peroxide**
- **Vinegar**
- **Water**
- **Small paper or plastic portion cups**

### Optional:

- It can be helpful to put the liquids into condiment bottles to aid in dispensing during facilitation of the activity



**Time Needed:** 1-2 class period  
**Grade Recommendation:** 5th-12th

## Preparation

Pre-measure amounts of the liquid materials that will be used during the paint making phase of the activity into the cups, or put each liquid in a separate condiment bottle to be dispensed after the students crush up their cochineal bugs. This should be done in advance, so students don't go overboard with the amounts of solutions used. It can also help to have an example painting of each chemical to be used as an illustration of what the resulting color will be.

## Engage

Ask them if they know how clothing is dyed. How do we get color in food? Why does clothing have different colors? What are ways we can change the color of an object? Did you know that bugs contain natural chemicals that can be used to make dyes?

Terms to introduce are opacity (the condition of lacking transparency or translucence), solution (a special type of homogeneous mixture composed of two or more substances), entomology (the branch of zoology concerned with the study of insects) and saturation (how something can be absorbed, combined with, or added).



## Explore

### Make a Paintbrush

Make a small hole into the object you will use for the handle using scissors or a small hand drill. The hole should only be small enough to fit the material you will be using for the bristles. This is best for older learners. For 4th-6th graders, have the students hot glue or use school glue to add their items directly to the stick.

Dip the material for the bristles into a small amount of glue to hold everything together. Place a dot of glue in the handle to attach the bristles to.

Wrap string around the tip to tighten the opening of the brush and to keep the bristles in. Glue the ends into place. Trim the bristles to the shape and length you desire.

Experiment with different materials for your bristle to test absorbency, pattern and size of brush stroke.

**YOUNG LEARNER TIP:**  
Use a clothespin as an alternative handle for small hands.

Students will make their own paintbrushes with found materials and create their own paint concoctions with natural chemicals and cochineal. This activity explores the natural world around us while blending the topics of chemistry and art with entomology. Learners will come away with their own custom paintbrushes and interesting works of art that are sure to be conversation-starters.

### Mix Paint Solutions

Take 15 to 20 dried cochineal and crush them with a mortar and pestle. Grind the cochineal down until it is a fine powder. Caution the students to use a grinding and crushing motion, not to slam the two pieces of the mortar and pestle together so hard that they break.

Test different solutions by mixing the cochineal powder with liquid bases. See if you can create different colors and consistencies with your paint.

Mark on a piece of paper or swatch what your solutions are. For example, "Cochineal + Hydrogen Peroxide = Light pink"

### Create a Work of Art

Use your paint mixtures to create a painting with your custom paintbrush. Try making an artwork with different textures and colors.

**Take it Further:** Discover other natural pigments like turmeric, spinach and cabbage to create a rainbow of colors with your paint.

### Explain and Expand

Design an art gallery in your space to showcase the creativity made using natural materials. Discuss with your students the different solutions they made. Here are a few talking points:

- What can you do to make a lighter paint color?
- What happened when you mixed the cochineal with liquid?
- How can we make different colored paint mixtures?
- What was the most absorbent material you used in your paintbrushes? Why was it so absorbent?
- What happens to some of the paints as you spread them on the paper? Why do you think this happens?
- What would happen if you left this painting out in the sun, or with half of it covered by something and half in the sun?
- Observe what happens when two colors are blended on the paper and record your results. Why do you think it changed to the color that it did?
- Would you eat a food that was colored with carmine from these bugs? (we enjoyed trolling the students by eating handfuls of Good 'n Plenty that contains this colorant while teaching this lesson...)

### Evaluate

Here are a few questions to ask during reflection:

- Are there any other insects that are used to make dyes or pigments?
- How is hue related to paint colors?
- What would happen if we added cochineal extract to white fabric?
- What did you learn about insect bodies today?
- What are other things in nature that can be used in everyday life?



Full online instructions for this activity can be found at:

[www.instructables.com/Make-PaintDye-From-Natural-Materials-Like-Cochinea](http://www.instructables.com/Make-PaintDye-From-Natural-Materials-Like-Cochinea)



# ACTIVITY 12: CARDBOARD CONSTRUCTION

## SUPPLIES

- Makedo screws
- Makedo screwdrivers and saws
- 3D-printed hinges and brackets for Makedo screws
- Cardboard - an assortment of big, medium and small boxes
- Markers, pencils or crayons

### Optional:

- It is helpful to have tool belts for each of the students (the two-pocket canvas ones available at most home supply or hardware stores are perfect)
- A variety of measuring tools like tape measures, carpenter's squares or bubble levels adds construction, design and engineering extensions
- If you are making a large-scale design with many screws it can help to have a drill and modify one of the screwdrivers to a hex shank bit for disassembly, but having many hands to disassemble works just as well!
- A parachute bag for fasteners is helpful to keep the 3D-printed brackets organized.

**Time Needed:** 1 class period

**Grade Recommendation:** 3rd-12th

## Preparation

Gather a number of boxes in advance. It doesn't matter if they are assembled or flattened. Big boxes like refrigerator boxes are fantastic. Large boxes that bikes are shipped in are generally available at most bike shops for free, just be sure to remove any staples in advance. Avoid very thick, tough boxes or waxed boxes for shipping fruit/vegetables - they are too hard to modify for young students. Pre-packing the belts with screws and tools in each can help if you have many classes back-to-back.

If you are using the 3D-printed brackets, make them in advance. They are not commercially available to purchase so have your local makerspace, FabLab or 3D printer at school create them, or order them to be printed online at vendors like Shapeways ([www.shapeways.com](http://www.shapeways.com)). See our online Instructable for source files and more links.

## Engage

Demonstrate how the screws, saws and brackets work. Students often overestimate how much they can build in the limited time of a class period with this activity, so setting expectations with the limitations of the tools and supplies is helpful. Have students work in groups together to create something, especially if they are intent on doing something big.

Introduce the concepts of measurement or determining angles with the carpenter's square and measuring tape. Discuss occupations that utilize these tools.





## Build a creation of your dreams using recycled cardboard, screw connectors, and 3D-printed brackets.

Kids love building anything out of cardboard - it's a common, generally free material that is endlessly useable for all sorts of things. Instead of using tape or glue, the addition of Makedo cardboard screws and associated tools in combination with 3D-printed brackets and hinges adds an additional engineering and design twist to this age-old activity.



### Explore

It can be helpful to establish a theme for the class to build creations within to help those students who might struggle to come up with an idea of what to build. General ideas like Jurassic Park in cardboard, Star Wars, Hogwarts, etc. allow for free iteration within the theme. Give students at least 30 minutes of building time, then regroup to share their designs, ideas, and challenges. Have students disassemble their creations at the end of the class period to reuse the materials, or better yet create a display to share with the rest of the school!



### Explain and Expand

Have students share their creations with the class. Here are a few questions to ask:

- Why did you choose to build what you did?
- What are some other things you might build with these materials?
- What additional materials might be helpful to use when building cardboard creation?
- What challenges did you face while making your creation?
- How could you combine what you built with the creation of another group?



### Evaluate

Here are a few questions to ask during reflection:

- How do the different brackets help to create different designs?
- Did you use the measurement tools to help you build your creation? How might they be helpful if you were building a house, bookshelves or other type of structure?
- How high do you think you could build a structure with these materials? What would you need to do to ensure it was sturdy?

**POINTER:** The plastic saws take quite a bit of effort to use. Score the cardboard with the point on the back of the saw to make things easier, and saw with the “grain” of the corrugation when possible.



Full online instructions for this activity can be found at:  
[www.instructables.com/Makedo-Cardboard-Construction-in-the-Classroom](http://www.instructables.com/Makedo-Cardboard-Construction-in-the-Classroom)



## ACTIVITY 13: CHOCOLATE WELDING

Weld pieces of chocolate together to test then taste with this delicious engineering activity.

### SUPPLIES

- **Chocolate** - Andes Mints work great
- **A paper plate**
- **Wax paper**
- **A glass jar or ceramic mug**
- **Hot water**
- **A fridge, freezer, or patience**

#### Optional:

- **A jig is useful to hold the pieces in place while they are cooling.**  
You can download and 3D print our design from the Instructable linked to in this activity, or cut your own from plastic food containers.
- **If you want to see how much weight your welded pieces will hold, you'll need a scale** - a bathroom scale is okay, but a postage scale or kitchen scale is ideal.
- **Heavy things like books or weights are good to use in testing, woodworking clamps are a suitable alternative**

**Time Needed:** 1 class period  
**Grade Recommendation:** 4th-8th

### Preparation

It's helpful to create a jig for your welding in advance. Jigs are used in all sorts of fabrication, from woodworking to welding to paper folding. Simply put, a jig is just something that holds your pieces in place in a specific orientation for a specific process or multiple processes. Ours will hold two pieces of chocolate together at a 90-degree angle while they are cooling.

Download and print the Mini Choco Jig from the linked Instructable for mini Hershey's bars or Andes Mints, or the full size jig for larger bars. If you are going to make your own from a different material, see the Instructable for a link to a video that demonstrates this.

Find your hot water source - a kettle, microwave, or stove all work fine - and get jars or mugs for each student or group of students. The water shouldn't be boiling - similar to a drinkable cup of coffee or tea in temperature is just fine.

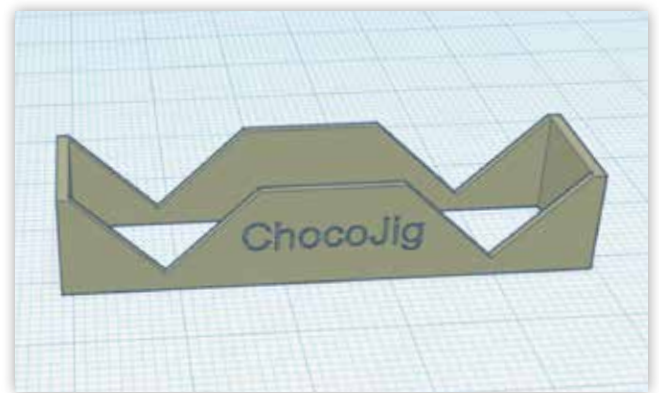

### The chocolate welding process uses a fusion welding technique.

This involves a localized melting of the material and then bonding the two surfaces together and stabilizing it until the material has cooled enough to provide a secured bond between them. This is really the same with both chocolate and metal. Fusion welding can be performed using gas, electricity or any other type of source that creates heat. It differs from other welding processes because it only uses the parent material and heat to create the bond between two objects. In other types of welding such as arc welding, welding rods or welding wire is added to the heating process in the presence of an inert gas in order to bond the two materials together.



Students will weld together pieces of chocolate with hot water in a jar to create a variety of welds, then test their strength. This activity is a great way to creatively explore engineering and structural integrity and discuss the phase changes of matter.

## ACTIVITY 13: CHOCOLATE WELDING

### Engage

We recommend having your students wash their hands before starting this activity - always a good idea these days, but especially when handling food that you want to eventually eat. If you have wax paper on hand, it helps immensely to wrap the jar with a sleeve of it and tape in place - this just makes cleanup of the jar much, much easier - chocolate is pretty fatty and greasy and hard to clean off the sides without a lot of soap.

Weld two pieces of chocolate together to demonstrate the process. Ask the students what welding is. Discuss the different kinds of welding processes. Present some examples of where welding is used, and discuss what types of materials are welded. The process we use here is a phase change of matter, so presents a good opportunity to discuss phase changes.

### Explore

We recommend doing this in two stages, with time in between to allow for the welds to cool and solidify. We will explore two different shapes of welds but there are other varieties you can explore - get creative with different shapes of chocolate candies!

#### To create a Box Section:

You'll need 4 separate pieces of chocolate/mints to create what's called a "box section" (called that because it looks like a box!). Take 1 Andes Mint and push the long edge against the side of the jar. Let it melt a bit until you get a good bead of chocolate, but don't leave it for so long that your piece starts to get too small. Start slow at first to make sure you don't melt it too much. Take your 2nd piece and do the same. Then, lay them so that the melted edges are touching each other in the jig. Create another set like this, so that you have filled up both slots in the jig. Once you've created this weld, you'll need to let it cool - it helps to stick it in the fridge or freezer for a few minutes. If it's cold outside, you can set it out there, or just wait for about 5 minutes at room temperature.

To finish your box section, take your assembly out of the fridge/freezer follow the steps above again. Melt the exposed long edges of the two right-angled pieces and assemble them together to form a square or rectangular box as shown, then set them in the jig in one of the slots and freeze/refrigerate again.



## ACTIVITY 13: CHOCOLATE WELDING



### To create an I-Beam:

As an alternative to the box section, you can create an I-beam (called that because it looks like the capital letter “I”). You just need 3 pieces of chocolate/mints for this. Melt the long edge of one piece as above against the side of the hot jar. Set it down on the face of another piece and hold it in place at a right angle, so it looks like an upside-down “T”. Blow on it for just a bit until it will stand up on its own, then stick it in the freezer or fridge for a few minutes. You can also set it outside in the cold, or wait about 5 minutes at room temperature.

To complete your I-beam, melt the other edge of the piece you melted in the previous step, place on the face of the other piece of chocolate at a right angle to form an “I”, then place in the fridge/freezer again.

### Test and Eat

Once your welded piece has cooled completely, it’s time to test out how much weight it will hold. Welders and engineers can test how strong their welds are by seeing how much weight they can bear. This is called a stress test or load test.

We like to use a kitchen scale and woodworking clamp, but something heavy like the weights shown or some clean bricks/blocks, etc. will work.

Use wax paper here so that whatever you are using to test the chocolate weld does not come in direct contact with it - it allows you to eat a clean piece of chocolate, and to keep whatever you are using to test chocolate smudge-free.

Turn on your scale if you’re trying to measure this and tare it with the chocolate piece on there. If you’re using a clamp, add the clamp and start squeezing slowly and keep an eye on the weight measurement. Squeeze incrementally until the piece breaks. How much weight did it hold? If you’re using weights, stack them on top of the piece until it breaks. How much weight could it bear?

We’ve found that these small welds can easily hold up to 20-25 pounds when built very well. If you’re using full size chocolate bars, it helps to straddle the weld over a span like a bridge so that it snaps in the middle - keep in mind that those can hold much more weight, so a scale that measures a higher range may be necessary.

Once you have tested your chocolate weld’s strength, it is time to test how delicious it is! Eating the chocolate makes cleanup much easier.



# ACTIVITY 13: CHOCOLATE WELDING

## Explain and Expand

Have students share their creations with the class. Here are a few questions to ask:

- Why are welded pieces of metal so strong?
- Both the box weld and I-beam will hold more weight as a bridge over a gap than just a single flat piece of chocolate. Why is that?
- What other candies or food items might we add to our design to make it stronger?
- Are there other shapes that we could weld our flat stock (chocolate pieces) into that would be structurally sound?

## Evaluate

Here are a few questions to ask during reflection:

- What would you change about your welded structure if you were to do it again?
- Would you consider a career in welding or fabrication? Why or why not?
- How might you demonstrate arc welding with food products like we did with fusion welding?
- What design could you weld with these materials that could hold more weight - like the weight of a grown adult standing on it?



Full online instructions for this activity can be found at:  
[www.instructables.com/Welding-With-Chocolate](http://www.instructables.com/Welding-With-Chocolate)



# Appendix

## SUPPORT DOCUMENTS

### Ozobots

- Ozocodes
- Ozobots Instruction Sheets

### Ziplines

- Zipline Speed Calculator

### Circuit Blocks

- Circuit Symbols

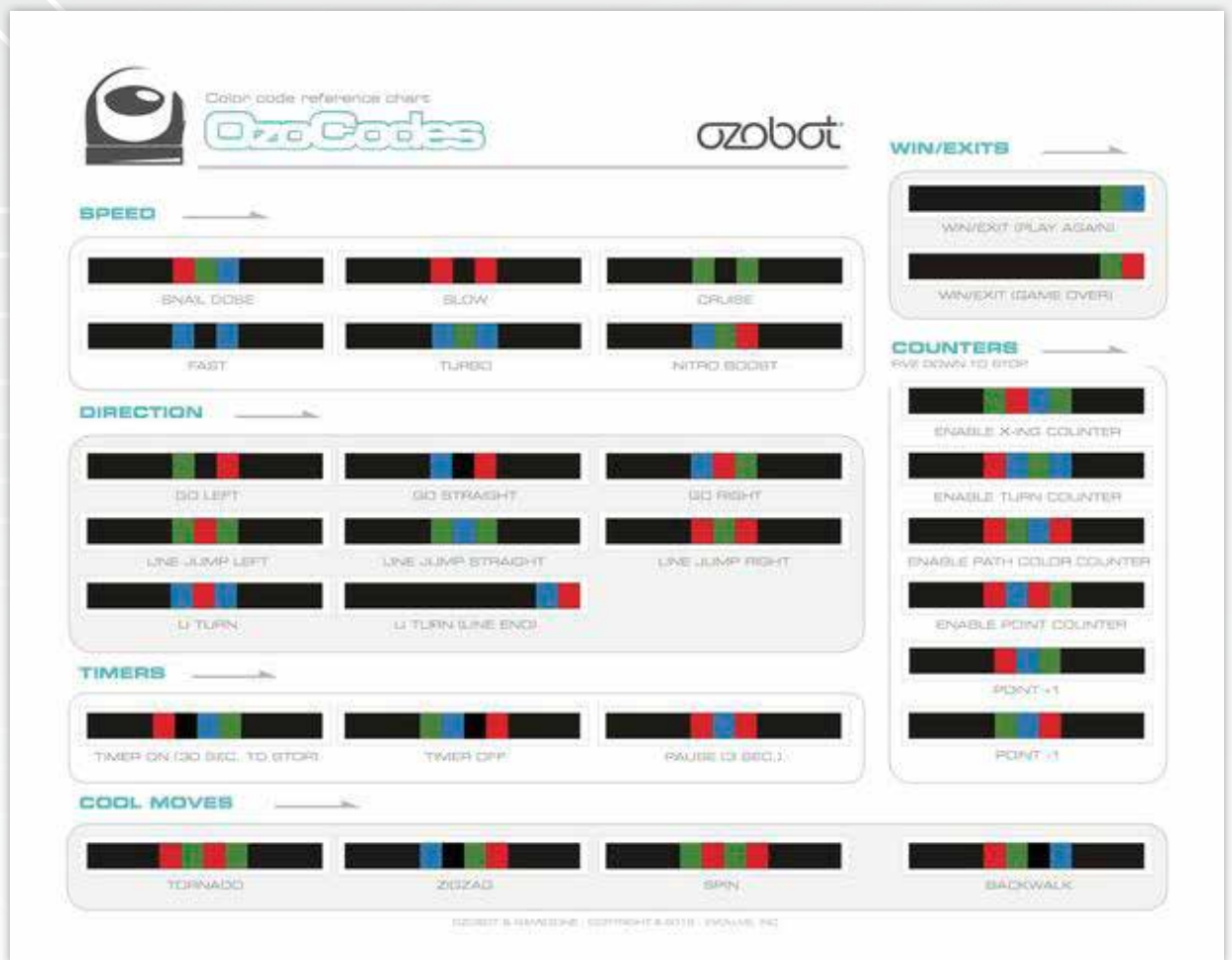

**Ozobots** Color code reference chart **OzoCodes**

**SPEED**

- SNAIL DOBE
- SLOW
- CRUISE
- FAST
- TURBO
- NITRO BOOST

**DIRECTION**

- GO LEFT
- GO STRAIGHT
- GO RIGHT
- LINE JUMP LEFT
- LINE JUMP STRAIGHT
- LINE JUMP RIGHT
- U TURN
- U TURN (LINE END)

**TIMERS**

- TIMER ON (30 SEC. TO STOP)
- TIMER OFF
- PAUSE (3 SEC.)

**COOL MOVES**

- TORNADO
- ZIGZAG
- SPIN
- BACKWALK

**WIN/EXITS**

- WIN/EXIT (PLAY AGAIN)
- WIN/EXIT (GAME OVER)

**COUNTERS**  
SWI DOWN TO STOP

- ENABLE X-ING COUNTER
- ENABLE TURN COUNTER
- ENABLE PATH COLOR COUNTER
- ENABLE POINT COUNTER
- POINT +1
- POINT -1

©2012 & REVISED | COPYRIGHT & 0111 | PIONEER, INC.

**Tips: Calibration**

1



Hold down the power button on Ozobot for 2 seconds until the LED light turns white.

2

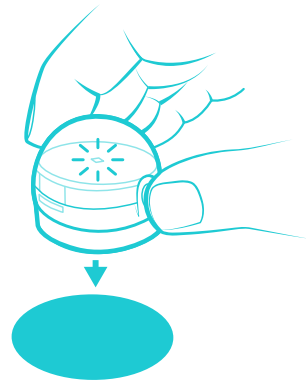

Quickly Place Ozobot in the middle of the black calibration dot.

3



Ozobot will move forward and blink green, which means it has successfully calibrated. Start over if Ozobot blinks red.

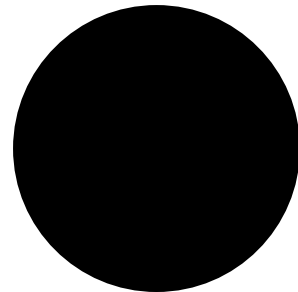

Use this black dot to calibrate.

**Tips: Drawing Lines**



**X**

Too Thin!

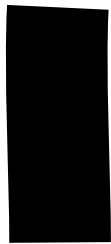

**X**

Too Thick!



**X**

Inconsistent!



**✓**

Just Right

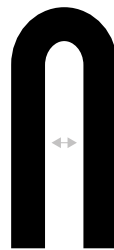

**X**

Too Close!

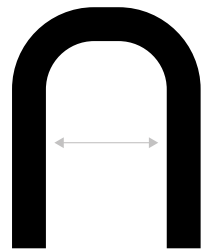

**✓**

Just Right

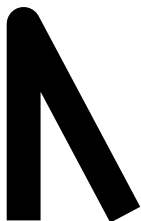

**X**

Too Sharp!

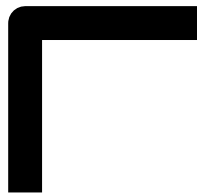

**✓**

Just Right

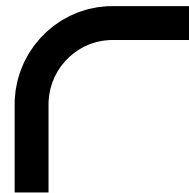

**✓**

Just Right

Name: \_\_\_\_\_

## Zipline Speed Calculator

1. How far did your racer travel? \_\_\_\_\_ **Inches**
2. How long was the flight of your racer? \_\_\_\_\_ **Seconds**
3. Divide the distance of your flight by the number of seconds.  
(For example, 100 inches / 2.3 seconds).  
Write that number here: \_\_\_\_\_ **Inches per Second**
4. Multiply the number in step 3 by 0.05681.
5. Write that number here: \_\_\_\_\_ **Miles per hour** Whoa, that's fast!



Name: \_\_\_\_\_

## Zipline Speed Calculator

1. How far did your racer travel? \_\_\_\_\_ **Inches**
2. How long was the flight of your racer? \_\_\_\_\_ **Seconds**
3. Divide the distance of your flight by the number of seconds.  
(For example, 100 inches / 2.3 seconds).  
Write that number here: \_\_\_\_\_ **Inches per Second**
4. Multiply the number in step 3 by 0.05681.
5. Write that number here: \_\_\_\_\_ **Miles per hour** Whoa, that's fast!





# Circuit SYMBOLS



Download these as full-sheet pdfs from our online Instructable

Piezo Speaker

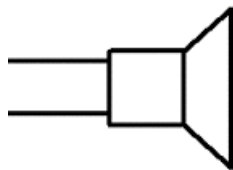

Battery

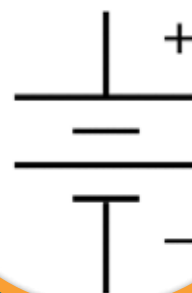

Knife Switch



Momentary Switch



LED



Motor

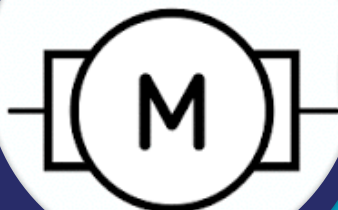

Potentiometer

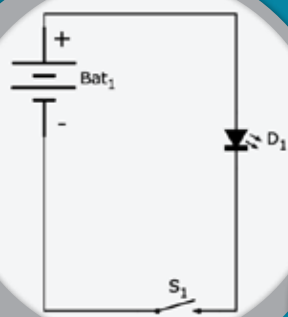

RGB LED

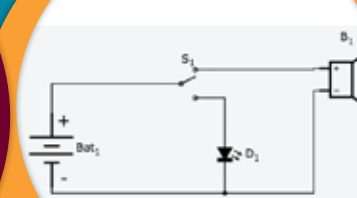
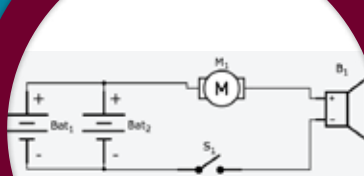
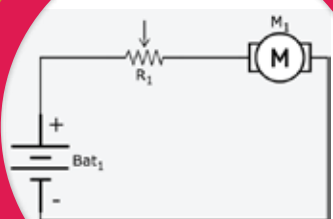
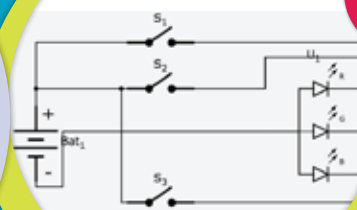
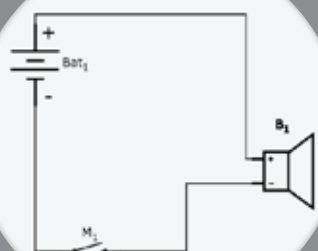
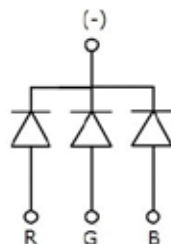

# NGSS Standards ADDRESSED

## SCIENCE & ENGINEERING PRACTICES:

- Planning and Carrying Out Investigations
- Asking Questions and Defining Problems
- Developing and Using Models
- Analyzing and Interpreting Data
- Constructing Explanations and Designing Solutions

## K-2

### K-PS2: Motion and Stability: Forces and Interactions

**K-PS2-1.** Plan and conduct an investigation to compare the effects of different strengths or different directions of pushes and pulls on the motion of an object.

**K-PS2-2.** Analyze data to determine if a design solution works as intended to change the speed or direction of an object with a push or pull.

### 2-PS1: Matter and its Interactions

**2-PS1-3.** Make observations to construct an evidence-based account of how an object made of a small set of pieces can be disassembled and made into a new object.

### K-2-ETS1: Engineering Design

**K-2-ETS1-1.** Ask questions, make observations, and gather information about a situation people want to change to define a simple problem that can be solved through the development of a new or improved object or tool.

**K-2-ETS1-2.** Develop a simple sketch, drawing, or physical model to illustrate how the shape of an object helps it function as needed to solve a given problem.

**K-2-ETS1-3.** Analyze data from tests of two objects designed to solve the same problem to compare the strengths and weaknesses of how each performs.

K-2nd	PS1: Matter and its Interactions	PS2: Motion and Stability: Forces and Interactions		EST1: Engineering Design		
	2-PS1-3	K-PS2-1	K-PS2-2	K-2-ETS1-1	K-2-ETS1-2	K-2-ETS1-3
Bouncy Rockets				X	X	
Ozobots						
Zipline Racers		X	X		X	X
Hovercrafts		X	X	X	X	
Light Play						
Squishy Circuits						X
Makey Makey						
Circuit Blocks	X					
Forced Perspective						
Strawbees	X			X	X	X
Cochineal Painting						
Cardboard Construction	X			X	X	X
Chocolate Welding	X			X	X	X

# 3-5

## 3-PS2: Motion and Stability: Forces and Interactions

**3-PS2-1.** Plan and conduct an investigation to provide evidence of the effects of balanced and unbalanced forces on the motion of an object.

**3-PS2-2.** Make observations and/or measurements of an object's motion to provide evidence that a pattern can be used to predict future motion.

## 4-PS3: Energy

**4-PS3-1.** Use evidence to construct an explanation relating the speed of an object to the energy of that object.

**4-PS3-2.** Make observations to provide evidence that energy can be transferred from place to place by sound, light, heat, and electric currents.

**4-PS3-4.** Apply scientific ideas to design, test, and refine a device that converts energy from one form to another.

## 4-PS4: Waves and their Applications in Technologies for Information Transfer

**4-PS4-2.** Develop a model to describe that light reflecting from objects and entering the eye allows objects to be seen.

**4-PS4-3.** Generate and compare multiple solutions that use patterns to transfer information.

## 5-PS1: Matter and Its Interactions

**5-PS1-3.** Make observations and measurements to identify materials based on their properties.

## 5-PS2: Motion and Stability: Forces and Interactions

**5-PS2-1.** Support an argument that the gravitational force exerted by Earth on objects is directed down.

## 3-5-ETS1: Engineering Design

**3-5-ETS1-1.** Define a simple design problem reflecting a need or a want that includes specified criteria for success and constraints on materials, time, or cost.

**3-5-ETS1-2.** Generate and compare multiple possible solutions to a problem based on how well each is likely to meet the criteria and constraints of the problem.

**3-5-ETS1-3.** Plan and carry out fair tests in which variables are controlled and failure points are considered to identify aspects of a model or prototype that can be improved.

3rd-5th	PS1: Matter and Its Interactions			PS2: Motion and Stability: Forces and Interactions			PS3: Energy			PS4: Waves and their Applications in Technologies for Information Transfer		ETS1: Engineering Design		
	5-PS1-3	3-PS2-1	3-PS2-2	5-PS2-1	4-PS3-1	4-PS3-2	4-PS3-4	4-PS4-2	4-PS4-3	3-5-ETS1-1	3-5-ETS1-2	3-5-ETS1-3		
Bouncy Rockets		X	X	X							X	X		
Ozobots									X		X	X		
Zipline Racers		X	X	X	X		X			X	X	X		
Hovercrafts											X	X		
Light Play								X						
Squishy Circuits	X					X	X				X	X		
Makey Makey	X					X								
Circuit Blocks	X					X			X		X			
Forced Perspective								X						
Strawbees		X	X					X		X	X	X		
Cochineal Painting	X													
Cardboard Construction		X	X				X			X	X	X		
Chocolate Welding	X			X		X				X	X	X		

# Middle School

## MS-PS2: Motion and Stability: Forces and Interactions

**MS-PS2-3.** Ask questions about data to determine the factors that affect the strength of electric and magnetic forces.

**MS-PS2-5.** Conduct an investigation and evaluate the experimental design to provide evidence that fields exist between objects exerting forces on each other even though the objects are not in contact.

## MS-PS3: Energy

**MS-PS4:** Waves and Their Applications in Technologies for Information Transfer  
**MS-PS4-3.** Integrate qualitative scientific and technical information to support the claim that digitized signals are a more reliable way to encode and transmit information than analog signals.

## MS-ETS1: Engineering Design

**MS-ETS1-1.** Define the criteria and constraints of a design problem with sufficient precision to ensure a successful solution, taking into account relevant scientific principles and potential impacts on people and the natural environment that may limit possible solutions.

**MS-ETS1-2.** Evaluate competing design solutions using a systematic process to determine how well they meet the criteria and constraints of the problem.

**MS-ETS1-3.** Analyze data from tests to determine similarities and differences among several design solutions to identify the best characteristics of each that can be combined into a new solution to better meet the criteria for success.

**MS-ETS1-4.** Develop a model to generate data for iterative testing and modification of a proposed object, tool, or process such that an optimal design can be achieved.

### MIDDLE SCHOOL

#### PS2: Motion and Stability: Forces and Interactions

#### PS4: Waves & Their Applications in Technologies for Information Transfer

#### ETS1: Engineering Design

	MS-PS2-3	MS-PS2-5	MS-PS4-3	MS-ETS1-1	MS-ETS1-2	MS-ETS1-3	MS-ETS1-4
Bouncy Rockets							
Ozobots			X				
Zipline Racers					X	X	X
Hovercrafts					X		
Light Play							
Squishy Circuits	X	X			X	X	
Makey Makey	X			X	X	X	
Circuit Blocks	X		X	X	X	X	
Forced Perspective							
Strawbees					X	X	X
Cochineal Painting					X	X	X
Cardboard Construction					X	X	X
Chocolate Welding				X	X	X	X

# ACKNOWLEDGEMENTS

The **Making and Tinkering Cookbook** - now in its 2nd version - has been the collaborative effort of many people too numerous to thank. So many teachers and educators from schools and museums around the US and beyond have provided feedback and encouragement. Here are just a few of the people that helped to make it happen:

Activities developed, tested, and written by

**Nick Wethington**

Instructables written by

**Nick Wethington**

Photographs are courtesy of

**Olga Helmy, Logan Castor Parson and Chandler Padgett**

Graphic design by

**Shauna Layton**

The spectr**UM** and **BIG** staff each contributed to this project using their own wide varieties of expertise. This includes:

**Nick Wethington, Jessie Herbert-Meny, Nathalie Wolfram, Logan Castor Parson, Hedi Casquilho-Gray, Caitlin Ervin, Seisin Eyer and Sara Bunton**

The **Bitterroot STEAM Advisory Group** has been a guiding force for implementation and encouragement with this project as well as many others that take place in the Bitterroot Valley.

The number of **teachers, librarians, principals, media specialists, and informal educators** that have given input on this cookbook is too long to list here. Our collaborations with the following schools have been instrumental in the development and testing of all of these activities:

**Corvallis Middle School and Primary School, Daly Elementary, Hamilton Middle School, Darby K-12 School, Frenchtown Elementary, and Stevensville High School and Middle School.**

**Thai Chang** from the Science Museum of Minnesota and **Brittney Kugler** of the Arkansas Museum of Discovery were instrumental in providing inspiration and support for our Making and Tinkering Institute, and graciously allowed us to reprint some of their ideas within these pages.

Each and every one of the **thousands of students** who have experienced these activities has contributed in their own way to their refinement through their suggestions, reactions and occasional mishaps.

The spectr**UM Discovery Area** and **UM Broader Impacts Group** are grateful to the **Martin Family Foundation** for their support of this project.

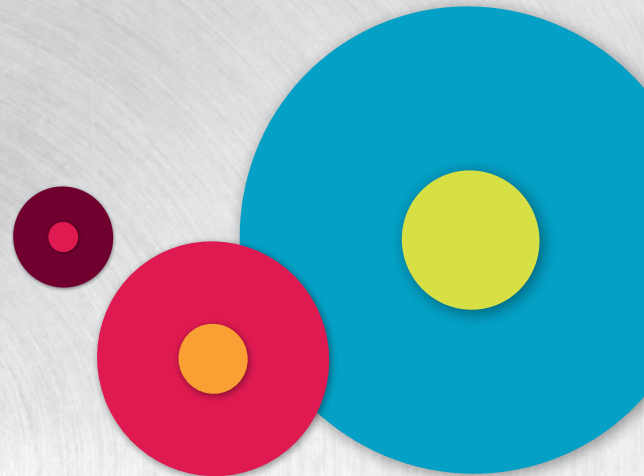

spectrUM DISCOVERY AREA

# Making & Tinkering

COOKBOOK VERSION 2.0